



## BASIC MANUAL

# HF/VHF/UHF ALL MODE TRANSCEIVER IC-705



This device complies with part 15 of the FCC Rules. Operation is subject to the condition that this device does not cause harmful interference.

Icom Inc.

Thank you for choosing this Icom product. This product is designed and built with Icom's state of the art technology and craftsmanship. With proper care, this product should provide you with years of trouble-free operation.

This product combines traditional analog technologies with the Digital Smart Technologies for Amateur Radio (D-STAR), for a balanced package.

## IMPORTANT

**READ ALL INSTRUCTIONS** carefully and completely before using the transceiver.

**SAVE THIS INSTRUCTION MANUAL**— This instruction manual contains basic operating instructions for the IC-705. For advanced operating instructions, see the Advanced Manual for details.

The Advanced Manual is available at the following internet address:

<https://www.icomjapan.com/support/>

## FEATURES

- **RF Direct Sampling System**

The IC-705 employs an RF direct sampling system under 25 MHz. RF signals are directly converted to digital data in the ADC, and then processed in the FPGA. This system is a leading technology, marking an epoch in amateur radio.

- **Real-Time Spectrum Scope**

The spectrum scope is class-leading in resolution, sweep speed, and dynamic range. When you touch the scope screen on the intended signal, the touched area is magnified. The large 4.3 inch color TFT touch LCD offers intuitive operation.

- **D-STAR operation**

The IC-705 has the D-STAR Repeater (DR) function.

- **A 4.3 inch touch panel color display**

- **Multi-function control for easy settings**

### About weld lines

This product's surfaces may have streaks called "weld lines," that occur during the molding process, and are not cracks or flaws.

## EXPLICIT DEFINITIONS

WORD	DEFINITION
⚠ <b>DANGER!</b>	Personal death, serious injury or an explosion may occur.
⚠ <b>WARNING!</b>	Personal injury, fire hazard or electric shock may occur.
<b>CAUTION</b>	Equipment damage may occur.
<b>NOTE</b>	Recommended for optimum use. No risk of personal injury, fire or electric shock.

## SUPPLIED ACCESSORIES

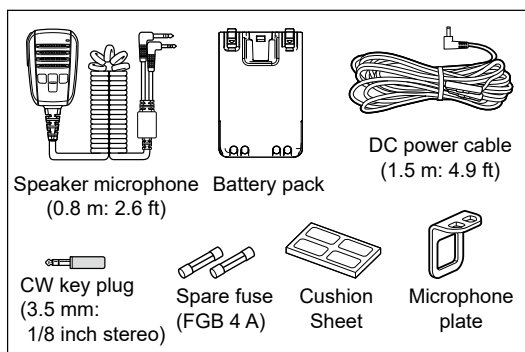

① Some accessories are not supplied, or the shape is different, depending on the transceiver version.

This product includes RTOS "RTX" software, and is licensed according to the software license.

This product includes "zlib" open source software, and is licensed according to the open source software license.

This product includes "libpng" open source software, and is licensed according to the open source software license.

Refer to the "About the Licenses" page at the end of the manual in English for information on the open source software being used in this product.

This software is based in part on the work of the Independent JPEG Group, and is licensed according to the open source software license.

---

## FCC INFORMATION

---

This equipment has been tested and found to comply with the limits for a Class B digital device, pursuant to part 15 of the FCC Rules. These limits are designed to provide reasonable protection against harmful interference in a residential installation. This equipment generates, uses and can radiate radio frequency energy and, if not installed and used in accordance with the instructions, may cause harmful interference to radio communications. However, there is no guarantee that interference will not occur in a particular installation. If this equipment does cause harmful interference to radio or television reception, which can be determined by turning the equipment off and on, the user is encouraged to try to correct the interference by one or more of the following measures:

- Reorient or relocate the receiving antenna.
- Increase the separation between the equipment and receiver.
- Connect the equipment into an outlet on a circuit different from that to which the receiver is connected.
- Consult the dealer or an experienced radio/TV technician for help.

**WARNING:** MODIFICATION OF THIS DEVICE TO RECEIVE CELLULAR RADIOTELEPHONE SERVICE SIGNALS IS PROHIBITED UNDER FCC RULES AND FEDERAL LAW.

**CAUTION:** Changes or modifications to this device, not expressly approved by Icom Inc., could void your authority to operate this device under FCC regulations.

Icom is not responsible for the destruction, damage to, or performance of any Icom or non-Icom equipment, if the malfunction is because of:

- Force majeure, including, but not limited to, fires, earthquakes, storms, floods, lightning, or other natural disasters, disturbances, riots, war, or radioactive contamination.
- The use of Icom transceivers with any equipment that is not manufactured or approved by Icom.

---

## DISPOSAL

---



The crossed-out wheeled-bin symbol on your product, literature, or packaging reminds you that in the European Union, all electrical and electronic products, batteries, and accumulators (rechargeable batteries) must be taken to designated collection locations at the end of their working life. Do not dispose of these products as unsorted municipal waste. Dispose of them according to the laws in your area.

---

## ABOUT CE AND DOC

---

**CE** Hereby, Icom Inc. declares that the versions of IC-705 which have the "CE" symbol on the product, comply with the essential requirements of the Radio Equipment Directive, 2014/53/EU, and the restriction of the use of certain hazardous substances in electrical and electronic equipment Directive, 2011/65/EU. The full text of the EU declaration of conformity is available at the following internet address:  
<https://www.icomjapan.com/support/>

---

## ABOUT SPURIOUS SIGNALS

---

Spurious signals may be received near the following frequencies. These are made in the internal circuit and does not indicate a transceiver malfunction:

- 28.378 MHz
- 28.524 MHz
- 29.621 MHz
- 50.467 MHz
- 51.343 MHz
- 51.509 MHz
- 51.564 MHz
- 51.674 MHz
- 52.222 MHz
- 52.661 MHz
- 438.602 MHz

---

## ABOUT THE TOUCH SCREEN

---

### ◇ Touch operation

In the Advanced Manual and the Basic Manual, the touch operation is described as shown below, with the beep tone ON.



#### Touch

If the display is touched briefly, one short beep sounds.



#### Touch for 1 second

If the display is touched for 1 second, one short and one long beep sound.

### ◇ Touch screen precautions

- The touch screen may not properly work when the LCD protection film or sheet is attached.
- Touching the screen with your finger nails, sharp topped object and so on, or touching the screen hard may damage it.
- Tablet PC operations such as flick, pinch in, and pinch out cannot be performed on this touch screen.

### ◇ Touch screen maintenance

- If the touch screen becomes dusty or dirty, wipe it clean with a soft, dry cloth.
- When you wipe the touch screen, be careful not to push it too hard or scratch it with your finger nails. Otherwise you may damage the screen.

---

## VOICE CODING TECHNOLOGY

---

The AMBE+2™ voice coding Technology embodied in this product is protected by intellectual property rights including patent rights, copyrights and trade secrets of Digital Voice Systems, Inc. This voice coding Technology is licensed solely for use within this Communications Equipment.

The user of this Technology is explicitly prohibited from attempting to extract, remove, decompile, reverse engineer, or disassemble the Object Code, or in any other way convert the Object Code into a human-readable form. U.S. Patent Nos.

#8,595,002, #8,359,197, #8,315,860,  
#8,200,497, #7,970,606, #6,912,495 B2.

---

## ABOUT THE MANUALS

---

You can use the following manuals to understand and operate this transceiver.

(As of October 2020)

**TIP:** You can download each manual and guide from the Icom website.

<https://www.icomjapan.com/support/>  
Enter "IC-705" into the Search box in the site.

- **Basic Manual (This manual)**  
Instructions for basic operations.
- **Advanced Manual (PDF type)**  
Instructions for advanced operations in English.
- **CI-V Reference Guide (PDF type)**  
Describes the control commands used in remote control operation (serial communication with CI-V) in English.
- **About the Share Pictures function (PDF type)**  
Describes how to use the Share Pictures function in English.

### For Reference

- **HAM Radio Terms (PDF type)**  
A glossary of HAM radio terms in English.

To read the manuals or Guide, Adobe® Acrobat® Reader® is required. If you have not installed it, please download the Adobe® Acrobat® Reader® and install it to your PC. You can download it from Adobe Systems Incorporated's website.

---

## TRADEMARKS

---

Icom, Icom Inc. and the Icom logo are registered trademarks of Icom Incorporated (Japan) in Japan, the United States, the United Kingdom, Germany, France, Spain, Russia, Australia, New Zealand, and/or other countries.

The Bluetooth word mark and logos are registered trademarks owned by the Bluetooth SIG, Inc. and any use of such marks by Icom Inc. is under license. Adobe, Acrobat, and Reader are either registered trademarks or trademarks of Adobe Systems Incorporated in the United States and/or other countries. AMBE+2 is a trademark and property of Digital Voice Systems Inc.

All other products or brands are registered trademarks or trademarks of their respective holders.

## ABOUT THE INSTRUCTIONS

The Advanced and Basic manuals are described in the following manner.

### “ ” (Quotation marks):

Used to indicate icons, setting items, and screen titles displayed on the screen.

The screen titles are also written in uppercase letters. (Example: FUNCTION screen)

### [ ] (brackets):

Used to indicate keys.

### Routes to the Set modes and Setting screens

Routes to the Set mode, Setting screens and the setting items are described in the following manner.

**[MENU]** » SET > Time Set > Date/Time > **Date**

#### Instruction example

##### ◇ Setting the date

1. Open the “Date” screen.

**[MENU]** » SET > Time Set > Date/Time > **Date**

2. Touch [+] or [-] to set the date.

### Detailed instruction

1. Push **[MENU]**.

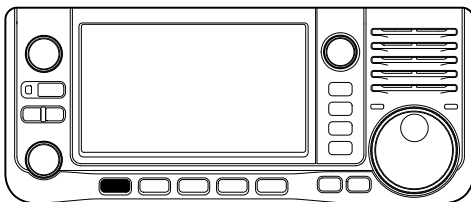

2. Touch **[SET]**.

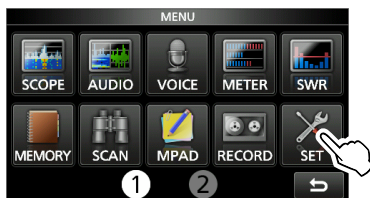

3. Touch **[▲]** or **[▼]** to scroll through the items.  
① You can also rotate **[MULTI]** to scroll through the items.

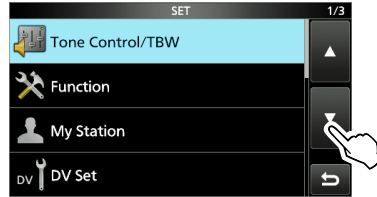

4. Touch “Time Set.”

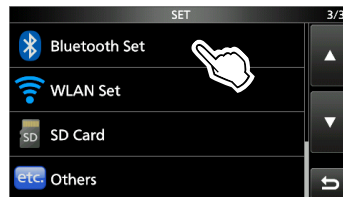

5. Touch “Date/Time.”

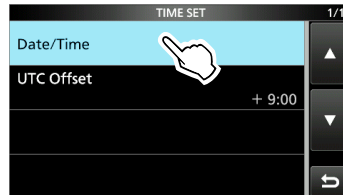

6. Touch “Date.”

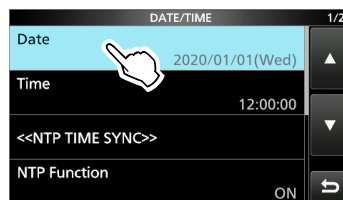

- Opens the “Date” screen.

# KEYBOARD ENTERING AND EDITING

## Keyboard types

You can select the Full Keyboard or Tenkey pad in "Keyboard Type" on the FUNCTION screen. (p. 8-7)

**MENU** » **SET > Function > Keyboard Type**

① You can also temporarily switch in the QUICK MENU screen by pushing **QUICK**.

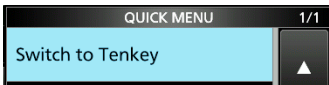
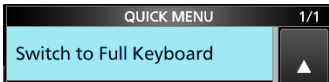

① You can select the full keyboard layout in "Full Keyboard Layout" on the FUNCTION screen. (p. 8-6)

**MENU** » **SET > Function > Full Keyboard Layout**

## Entering and editing

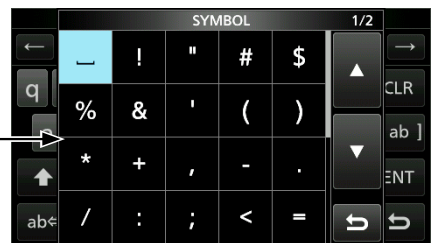
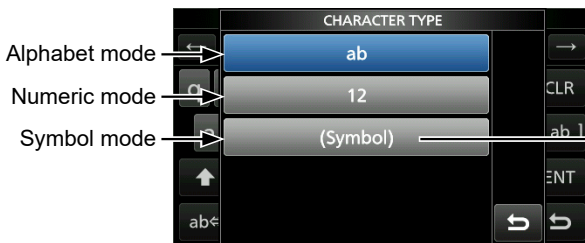
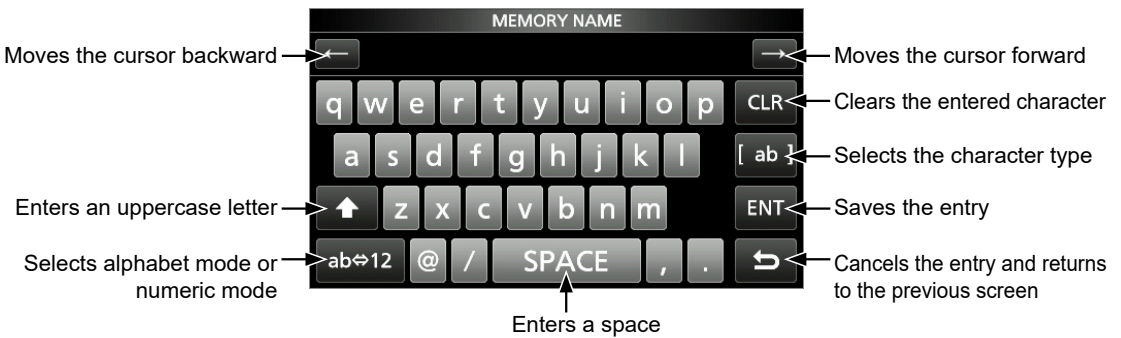

## USABLE CHARACTERS

You can enter and edit the items in the following table.

Menu	Category	Item	Selectable characters	Maximum characters	
SET	My Station	My Call Sign	A to Z, 0 to 9, (space), /	8 + 4	
		TX Message	[AB] [ab] [12] [!"#]	20	
	Time Set	NTP Server Address	A to Z, a to z, 0 to 9, - .	64	
	Bluetooth Set	Bluetooth Device Information (Edit Name)	[AB] [ab] [12] [!"#]	9* <sup>1</sup>	
		WLAN Set	SSID	[AB] [ab] [12] [!"#]	32
			Password	[AB] [ab] [12] [!"#]	64
			Network Name	A to Z, 0 to 9, ! " # \$ % & ( ) + , . - ; = @ [ ] ^	15
			Network User 1/2 ID	[AB] [ab] [12] [!"#]	16
			Network User 1/2 Password	[AB] [ab] [12] [!"#] • Illegal characters: \ (space)	16* <sup>2</sup>
			Network Radio Name	[AB] [ab] [12] [!"#]	16
SD Card		Save Setting	[AB] [ab] [12] [!"#]	23	
		Export	• Illegal characters: / : ; * < > \		
MEMORY		GROUP NAME, MEMORY NAME	[AB] [ab] [12] [!"#]	16	
SCAN	Program Scan Edge	NAME	[AB] [ab] [12] [!"#]	16	
KEYER		Keyer Memory	A to Z, 0 to 9, (space), / ? ^ . , @ • "*" (asterisk) has its own unique use.	70	
DECODE		RTTY Memory	A to Z, 0 to 9, (space), ! \$ & ? " ' - / . , : ; ( ) _	70	
VOICE		VOICE TX RECORD	[AB] [ab] [12] [!"#]	16	
CS		UR, R1, R2	A to Z, 0 to 9, (space), /	8	
DV MEMORY	Your Call Sign	NAME	[AB] [ab] [12] [!"#]	16	
		CALL SIGN	A to Z, 0 to 9, (space), /	8	
	Repeater List	GROUP NAME, NAME	[AB] [ab] [12] [!"#]	16	
		SUB NAME	[AB] [ab] [12] [!"#]	8	
DV GW	Internal Gateway Settings	CALL SIGN, GW CALL SIGN	A to Z, 0 to 9, (space), /	8	
		Gateway Repeater (Server IP/Domain)	A to Z, a to z, 0 to 9, - .	64	
		Terminal/AP Call sign, Allowed Call Sign List	A to Z, 0 to 9, (space)	8	
GPS	GPS TX Mode	Unproto Address	[AB] [ab] [12] [!"#]	56* <sup>3</sup>	
		Object Name, Item Name	[AB] [ab] [12] [!"#]	9	
		Comment	[AB] [ab] [12] [!"#]	43* <sup>4</sup>	
		GPS Message	[AB] [ab] [12] [!"#]	20	
	GPS Memory	GROUP NAME, NAME	[AB] [ab] [12] [!"#]	16	
DTMF	DTMF MEMORY		0 to 9, A B C D * #	24	
	SEND	Direct Input	0 to 9, A B C D * #	24	
DR	TO SELECT	Direct input (UR)/(RPT)	A to Z, 0 to 9, (space), /	8	

[AB]: A to Z, (space)

[ab]: a to z, (space)

[12]: 0 to 9, (space)

[!"#]: ! " # \$ % & ' ( ) \* + , - . / : ; < = > ? @ [ \ ] ^ \_ ` { } ~ (space)

\*<sup>1</sup> Except for "ICOM BT"

\*<sup>2</sup> Minimum of 8 characters

\*<sup>3</sup> Normally 12 characters

\*<sup>4</sup> The maximum number of characters you can enter depends on the data extension and altitude settings.

# TABLE OF CONTENTS

IMPORTANT.....	i	Using the VFO mode .....	3-1
FEATURES.....	i	◇ Selecting VFO A or VFO B .....	3-1
EXPLICIT DEFINITIONS.....	i	◇ Equalizing VFO A and VFO B.....	3-1
SUPPLIED ACCESSORIES.....	i	Selecting the operating band .....	3-2
FCC INFORMATION .....	ii	Selecting the operating mode .....	3-2
DISPOSAL.....	ii	Setting the frequency .....	3-3
ABOUT CE AND DOC.....	ii	◇ Using the Main Dial .....	3-3
ABOUT SPURIOUS SIGNALS.....	ii	◇ About the Tuning Step function.....	3-3
ABOUT THE TOUCH SCREEN .....	iii	◇ Changing the Tuning Step.....	3-3
◇ Touch operation.....	iii	◇ About the 1 Hz step Fine Tuning function ...	3-3
◇ Touch screen precautions .....	iii	◇ About the 1/4 Tuning function.....	3-3
◇ Touch screen maintenance .....	iii	◇ About the Auto Tuning Step function.....	3-3
VOICE CODING TECHNOLOGY.....	iii	◇ Directly entering a frequency.....	3-4
ABOUT THE MANUALS.....	iii	◇ Band Edge Beep .....	3-5
TRADEMARKS.....	iii	◇ Entering a Band Edge .....	3-5
ABOUT THE INSTRUCTIONS .....	iv	Dial Lock function.....	3-8
KEYBOARD ENTERING AND EDITING .....	v	RF gain and SQL level.....	3-8
USABLE CHARACTERS.....	vi	Meter display.....	3-9
PRECAUTIONS.....	ix	◇ Meter display selection.....	3-9
BATTERY CAUTIONS.....	xi	◇ Multi-function meter.....	3-9
◇ Battery caution .....	xi	Adjusting the transmit output power.....	3-9
◇ Charging caution .....	xii	Setting the maximum transmit power.....	3-10
IMPORTANT NOTES .....	xii	Adjusting the microphone gain.....	3-10
◇ When using the GPS receiver.....	xii	<b>4 RECEIVING AND TRANSMITTING .....</b>	<b>4-1</b>
◇ Electromagnetic Interference .....	xii	Preamplifiers .....	4-1
<b>1 INITIAL SETUP.....</b>	<b>1-1</b>	Attenuator .....	4-1
Selecting a location.....	1-1	RIT function.....	4-2
Connecting a microphone .....	1-1	◇ RIT monitor function .....	4-2
Attaching the cushions.....	1-1	Monitor function .....	4-2
Attaching the Battery pack.....	1-1	AGC function control.....	4-3
Charging the battery pack.....	1-2	◇ Selecting the AGC time	
◇ Battery icon .....	1-2	constant preset value .....	4-3
◇ Charging time.....	1-2	◇ Setting the AGC time constant .....	4-3
◇ Charging with a USB cable .....	1-2	Using the Digital Twin PBT .....	4-4
<b>2 PANEL DESCRIPTION.....</b>	<b>2-1</b>	Selecting the IF filter .....	4-5
Front panel.....	2-1	Selecting the IF filter shape .....	4-5
Bottom panel.....	2-2	Notch Filter.....	4-6
Side panels .....	2-3	◇ Selecting the Notch filter type.....	4-6
Speaker Microphone.....	2-3	◇ Setting the Manual Notch filter .....	4-6
Touch screen display .....	2-4	Noise Blanker.....	4-7
◇ FUNCTION screen .....	2-6	◇ Adjusting the NB level and time .....	4-7
◇ MENU screen .....	2-7	Noise Reduction.....	4-8
◇ QUICK MENU .....	2-7	◇ Adjusting the Noise Reduction level.....	4-8
◇ Multi-function menus .....	2-7	Setting the transmit filter width.....	4-8
Multi-function dial .....	2-8		
<b>3 BASIC OPERATION.....</b>	<b>3-1</b>		
When first applying power.....	3-1		
Selecting the mode .....	3-1		
Turning power ON or OFF .....	3-1		
Adjusting the volume level .....	3-1		



Setting the Speech Compressor .....	4-9	Time Set.....	8-18
◇ Setting before using		Bluetooth Set .....	8-18
the Speech Compressor function .....	4-9	WLAN Set .....	8-20
◇ Using the Speech Compressor function.....	4-9	SD Card .....	8-22
Split frequency operation .....	4-10	Others .....	8-23
◇ Using the Quick Split function .....	4-10	<b>9 CLOCK .....</b>	<b>9-1</b>
◇ Using the receive and transmit frequencies		Setting the date and time .....	9-1
set to VFO A and VFO B .....	4-11	◇ Setting the date .....	9-1
Split Lock function.....	4-11	◇ Setting the current time .....	9-1
Operating CW .....	4-11	◇ Setting the UTC offset.....	9-1
◇ Setting the CW pitch control.....	4-11	<b>10 MAINTENANCE .....</b>	<b>10-1</b>
◇ Setting the key speed.....	4-11	Cleaning.....	10-1
◇ Using the Break-in function .....	4-12	Replacing fuse .....	10-1
◇ Monitoring the CW side tone.....	4-12	Resetting.....	10-1
◇ About the electronic Keyer function.....	4-13	◇ Partial reset .....	10-2
Auto Tuning function .....	4-13	◇ All reset .....	10-2
<b>5 SCOPE OPERATION .....</b>	<b>5-1</b>	Troubleshooting .....	10-3
Spectrum scope screen .....	5-1	<b>11 SPECIFICATIONS .....</b>	<b>11-1</b>
◇ Marker .....	5-1	◇ General.....	11-1
◇ Using the Spectrum Scope.....	5-1	◇ Transmitter .....	11-1
◇ Center mode.....	5-2	◇ Receiver .....	11-2
◇ Fixed mode.....	5-2	◇ Wireless LAN.....	11-3
◇ Touch screen operation .....	5-2	◇ Bluetooth .....	11-3
◇ Mini scope screen .....	5-2	<b>12 OPTIONS.....</b>	<b>12-1</b>
Audio scope screen .....	5-3	Options.....	12-1
◇ AUDIO SCOPE SET screen.....	5-3	<b>13 CONNECTOR INFORMATION.....</b>	<b>13-1</b>
<b>6 microSD CARD.....</b>	<b>6-1</b>	[DC 13.8 V] .....	13-1
About the microSD cards .....	6-1	Connecting an external	
Saving data .....	6-1	DC power supply.....	13-1
Inserting .....	6-1	Grounding .....	13-2
Formatting.....	6-1	[SEND/ALC].....	13-2
Saving the setting data .....	6-2	[KEY].....	13-2
Unmounting.....	6-2	[microUSB].....	13-3
<b>7 GPS OPERATION .....</b>	<b>7-1</b>	[SP] .....	13-3
Confirming the GPS signal receiving .....	7-1	[MIC] .....	13-3
Checking your location.....	7-1	[ANT].....	13-3
GPS Logger function.....	7-2	INSTALLATION NOTES .....	I
<b>8 SET MODE .....</b>	<b>8-1</b>	SAFETY TRAINING INFORMATION.....	II
Set mode description .....	8-1	ABOUT THE LICENSES .....	III
Tone Control/TBW.....	8-2	INDEX.....	V
Function .....	8-2		
My Station.....	8-8		
DV Set.....	8-8		
QSO/RX Log .....	8-10		
Connectors.....	8-13		
Display .....	8-15		

---

## PRECAUTIONS

---

⚠ **DANGER HIGH RF VOLTAGE! NEVER** touch an antenna, an antenna connector, or a ground terminal while transmitting. This could cause an electrical shock or burn.

⚠ **DANGER! NEVER** operate the transceiver near unshielded electrical blasting caps or in an explosive atmosphere. This could cause an explosion and death.

⚠ **DANGER! NEVER** use or charge Icom battery packs with non-Icom transceivers or non-Icom chargers. Only Icom battery packs are tested and approved for use with Icom transceivers or charged with Icom chargers. Using thirdparty or counterfeit battery packs or chargers may cause smoke, fire, or cause the battery to burst.

⚠ **WARNING RF EXPOSURE!** This transceiver emits Radio Frequency (RF) energy. Extreme caution should be observed when operating this transceiver. If you have any questions regarding RF exposure and safety standards please refer to the Federal Communications Commission Office of Engineering and Technology's report on Evaluating Compliance with FCC Guidelines for Human Radio Frequency Electromagnetic Fields (OET Bulletin 65).

⚠ **WARNING! NEVER** hold the transceiver so that the antenna is very close to, or touching exposed parts of the body, especially the face or eyes, while transmitting. If the antenna is close to you, transmit with low power.

⚠ **WARNING! NEVER** operate the transceiver with earphone, a headset, or other audio accessories at high volume levels. If you experience a ringing in your ears, reduce the volume or discontinue use.

⚠ **WARNING! NEVER** apply AC power to the [DC 13.8 V] jack on the transceiver side panel. This could cause a fire or damage the transceiver.

⚠ **WARNING! NEVER** apply more than 16 V DC to the [DC 13.8 V] jack on the transceiver side panel. This could cause a fire or damage the transceiver.

⚠ **WARNING! NEVER** reverse the DC power cable polarity. This could cause a fire or damage the transceiver.

⚠ **WARNING! NEVER** remove the fuse holder on the DC power cable. Excessive current caused by a short could cause a fire or damage the transceiver.

⚠ **WARNING! NEVER** let metal, wire or other objects contact the inside of the transceiver, or make incorrect contact with connectors on the side panel. This could cause an electric shock or damage the transceiver.

⚠ **WARNING! NEVER** operate or touch the transceiver with wet hands. This could cause an electric shock or damage to the transceiver.

⚠ **WARNING! NEVER** operate the equipment if you notice an abnormal odor, sound or smoke. Immediately turn OFF the power and/or remove the battery pack and the DC power cable. Contact your Icom dealer or distributor for advice.

⚠ **WARNING! NEVER** put the transceiver on an unstable place where the transceiver may suddenly move or fall. This could cause an injury or damage the transceiver.

⚠ **WARNING! NEVER** operate the transceiver during a lightning storm. It may result in an electric shock, cause a fire or damage the transceiver. Always disconnect the power source and antenna before a storm.

**CAUTION: DO NOT** expose the transceiver to rain, snow or any liquids. They could damage the transceiver.

**CAUTION: DO NOT** operate the transceiver unless the flexible antenna, battery pack, and jack covers are securely attached to the transceiver, and that the antenna and battery pack are dry before attachment. Exposing the inside of the transceiver to dust or water will result in serious damage to the transceiver.

**CAUTION: DO NOT** operate the transceiver while driving a vehicle. Safe driving requires your full attention—anything less may result in an accident.

**CAUTION: DO NOT** short the terminals of the battery pack. Shorting may occur if the terminals touch metal objects such as a key, so be careful when placing the battery packs (or the transceiver) in bags, and so on. Carry them so that shorting cannot occur with metal objects. Shorting may damage not only the battery pack, but also the transceiver.

**CAUTION: DO NOT** change the internal settings of the transceiver. This could reduce transceiver performance and/or damage to the transceiver. The transceiver warranty does not cover any problems caused by unauthorized internal adjustments.

**CAUTION: DO NOT** install or place the transceiver in a place without adequate ventilation, or block any cooling vents on the rear of the transceiver. Heat dissipation may be reduced and damage the transceiver.

---

---

**CAUTION: NEVER** use harsh solvents such as Benzine or alcohol when cleaning. This could damage the transceiver surfaces. If the surface becomes dusty or dirty, wipe it clean with a soft, dry cloth.

**CAUTION: DO NOT** leave the transceiver in areas with temperatures below  $-10^{\circ}\text{C}$  ( $+14^{\circ}\text{F}$ ) or above  $+60^{\circ}\text{C}$  ( $+140^{\circ}\text{F}$ ) for mobile operations.

**CAUTION: DO NOT** place the transceiver in excessively dusty environments. This could damage the transceiver.

**CAUTION: DO NOT** place the transceiver against walls or putting anything on top of the transceiver. This may overheat the transceiver.

**CAUTION: DO NOT** set the transceiver's RF output power to more than a connected linear amplifier's maximum input level. Otherwise, the linear amplifier will be damaged.

**CAUTION: DO NOT** use non-Icom microphones. Other microphones have different pin assignments, and may damage the transceiver.

**DO NOT** push PTT unless you actually intend to transmit.

**BE CAREFUL!** The transceiver may become hot after continuously transmitting for long periods of time.

**NEVER** leave the transceiver in an insecure place to avoid use by unauthorized persons.

Turn OFF the transceiver's power and disconnect the DC power cable when you will not use the transceiver for long period of time.

Even when the transceiver power is OFF, a slight current still flows in the circuits. Remove the battery pack from the transceiver when not using it for a long time. Otherwise, the attached battery pack will become exhausted, and will need to be recharged or replaced.

The LCD display may have cosmetic imperfections that appear as small dark or light spots. This is not a malfunction or defect, but a normal characteristic of LCD displays.

---

# BATTERY CAUTIONS

---

## ◇ Battery caution

Misuse of Li-ion batteries may result in the following hazards: smoke, fire, or the battery may rupture. Misuse can also cause damage to the battery or degradation of battery's performance.

⚠ **DANGER! NEVER** incinerate used battery packs. Internal battery gas may cause an explosion.

⚠ **DANGER! NEVER** strike or otherwise impact the battery pack. Do not use the battery pack if it has been severely impacted or dropped, or if the pack has been subjected to heavy pressure. Battery pack damage may not be visible on the outside of the case. Even if the surface of the battery does not show cracks or any other damage, the cells inside the battery may rupture or catch fire.

⚠ **DANGER! NEVER** leave the battery pack in places with temperatures above 60°C (140°F). High temperature buildup in the battery cells, such as could occur near fires or stoves, inside a sun-heated vehicle, or in direct sunlight for long periods of time may cause the battery cells to rupture or catch fire. Excessive temperatures may also degrade the battery pack's performance or shorten the battery cell's life.

⚠ **DANGER! NEVER** place battery packs near a fire. Fire or heat may cause them to rupture or explode. Dispose of used battery packs in accordance with local regulations.

⚠ **DANGER! NEVER** solder the battery terminals, or **NEVER** modify the battery pack. This may cause heat generation, and the battery may burst, emit smoke or catch fire.

⚠ **DANGER! NEVER** let fluid from inside the battery get in your eyes. This can cause blindness. Rinse your eyes with clean water, without rubbing them, and immediately go to a doctor.

⚠ **WARNING! NEVER** let fluid from inside the battery cells come in contact with your body. If it does, immediately wash with clean water.

⚠ **WARNING! NEVER** put the battery pack in a microwave oven, high-pressure container, or in an induction heating cooker. This could cause a fire, overheating, or cause the battery cells to rupture.

⚠ **WARNING! NEVER** use deteriorated battery packs. They could cause a fire.

**CAUTION: DO NOT** expose the battery pack to rain, snow, saltwater, or any other liquids. Do not charge or use a wet pack. If the pack gets wet, be sure to wipe it with a clean dry cloth before using.

**CAUTION: DO NOT** continue to use the battery pack if it emits an abnormal odor, heats up, or is discolored or deformed. If any of these conditions occur, contact your Icom dealer or distributor.

**CAUTION: DO NOT** use the battery pack out of the specified temperature range for the transceiver (-10°C ~ +60°C (14°F ~ +140°F)) and the battery itself (-20°C ~ +60°C (-4°F ~ +140°F)). Using the battery out of its specified temperature range will reduce its performance and battery cell's life. Please note that the specified temperature range of the battery may exceed that of the transceiver. In such cases, the transceiver may not work properly because it is out of its operating temperature range.

**CAUTION: DO NOT** leave the pack fully charged, completely discharged, or in an excessive temperature environment (above 50°C, 122°F) for an extended period of time. Otherwise a shorter battery pack life could occur. If the battery pack must be left unused for a long time, it must be detached from the transceiver after discharging. You may use the battery pack until the remaining capacity is about half, then keep it safely in a cool and dry place at the following temperature range:

- 20°C (-4°F) ~ +50°C (+122°F) (within a month).
- 20°C (-4°F) ~ +35°C (+95°F)\* (within three months).
- 20°C (-4°F) ~ +20°C (+68°F) (within a year).
- \* BP-307: -20°C (-4°F) ~ +40°C (+104°F)

**BE SURE** to replace the battery pack with a new one approximately five years after manufacturing, even if it still holds a charge. The material inside the battery cells will become weak after a period of time, even with little use. The estimated number of times you can charge the pack is between 300 and 500. Even when the pack appears to be fully charged, the operating time of the transceiver may become short when:

- Approximately five years have passed since the pack was manufactured.
- The pack has been repeatedly charged.

---

---

## ◇ Charging caution

⚠ **DANGER! NEVER** charge the battery pack in areas with extremely high temperatures, such as near fires or stoves, inside a sun-heated vehicle, or in direct sunlight. In such environments, the safety/protection circuit in the battery will activate and stop the charging.

⚠ **WARNING! NEVER** charge the transceiver during a lightning storm. It may result in an electric shock, cause a fire or damage the transceiver. Always disconnect the power adapter before a storm.

⚠ **WARNING! NEVER** charge or leave the battery in the battery charger beyond the specified time for charging. If the battery is not completely charged by the specified time, stop charging and remove the battery from the battery charger. Continuing to charge the battery beyond the specified time limit may cause a fire, overheating, or the battery may rupture.

⚠ **WARNING!** Occasionally observe the battery pack condition while charging. If any abnormal condition occurs, discontinue using the battery pack.

**CAUTION: DO NOT** insert the battery pack into the charger if it is wet or soiled. This could corrode the battery charger terminals or damage the charger. The charger is not waterproof.

**CAUTION: DO NOT** charge the battery pack outside of the specified temperature range: 10°C ~ 40°C (50°F ~ 104°F). Icom recommends charging the pack at 25°C (77°F). The pack may heat up or rupture if charged out of the specified temperature range. Additionally, battery performance or battery life may be reduced.

---

## IMPORTANT NOTES

### ◇ When using the GPS receiver

- The GPS receiver is installed under the transceiver's top panel. Therefore, when the GPS receiver is activated, do not cover the top with anything that will block the satellite signals.
- GPS signals cannot pass through metal objects. When using the transceiver inside a vehicle, you may not receive GPS signals. We recommend you use it near a window.
- The Global Positioning System (GPS) is built and operated by the U.S. Department of Defense. The Department is responsible for accuracy and maintenance of the system. Any changes by the Department may affect the accuracy and function of the GPS system.
- The GPS receiver may not work if the transceiver operates near 440.205 MHz. This is due to signals made in the internal circuit, and does not indicate a transceiver malfunction.
- The GPS receiver may not work if used in the following locations:
  - Tunnels or high-rise buildings
  - Underground parking lots
  - Under a bridge or viaduct
  - In remote forested areas
  - Under bad weather conditions (rainy or cloudy day)

### ◇ Electromagnetic Interference

When you use a Wireless LAN or Bluetooth function, pay attention to the following: Wireless LAN products and Bluetooth devices operate in the 2.4 GHz band. The 2.4 GHz band is also used by other devices, such as microwave ovens, RFID systems, amateur radio stations, and so on.

When using this device near such devices, interference may occur, causing a decrease in communication speed, and an unstable connection. In such cases, use this device away from the other devices, or stop using those devices.

## Selecting a location

Select a location for the transceiver that allows adequate air circulation, free from extreme heat, cold, or vibration, and other electromagnetic sources.

Never place the transceiver in areas such as:

- Temperatures that are below  $-10^{\circ}\text{C}$  ( $+14^{\circ}\text{F}$ ) or above  $+60^{\circ}\text{C}$  ( $+140^{\circ}\text{F}$ ).
- An unstable place that slopes or vibrates.
- In direct sunlight.
- High humidity and temperature environments.
- Dusty environments.
- Noisy environments.

## Connecting a microphone

Plug the microphone into the [SP/MIC] jack, and attach the microphone's cable to the microphone plate to avoid cable breaks.

① Confirm that the transceiver is OFF before connecting or disconnecting optional equipment.

1. Attach the microphone's split ring to the plate.
2. Attach the microphone plate to the [GND] terminal with its bolt.
3. Plug the microphone into the [SP/MIC] jacks. (SP: 3.5 mm (1/8 inch), MIC: 2.5 mm)

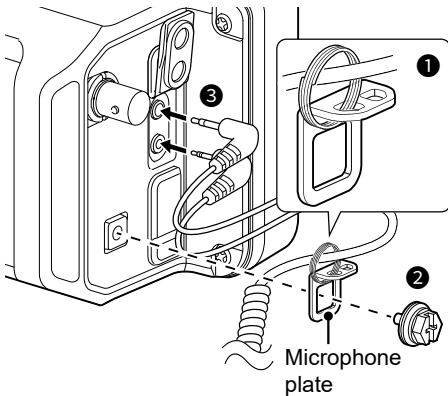

① When you connect other devices to the [SP/MIC] jacks, attach the cable to the plate through the split ring (User supplied).

## Attaching the cushions

Attach the cushions, as illustrated below.

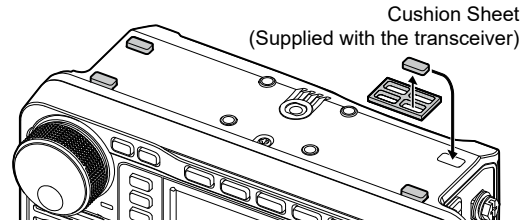

## Attaching the Battery pack

Attach or detach the battery pack, as illustrated below.

① When attaching, slide the battery pack and hold it down until the both latches are locked.

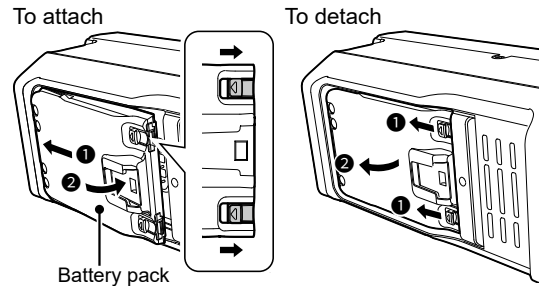

### NOTE:

- Keep the battery pack attached, even when using an external power supply.
  - Even when the transceiver power is OFF, a small current still flows in the transceiver. Remove the battery pack from the transceiver when not using it for a long time. Otherwise, the attached battery pack will become exhausted.
  - When the temperature is around  $0^{\circ}\text{C}$  ( $+32^{\circ}\text{F}$ ) or below, the battery protection function automatically sets transceiver power to 0.5 W, and disables power selections (1 W, 2.5 W, 5 W, and 10 W\*).
- \* "10 W" can be selected only when using an external DC power supply.

## Charging the battery pack

**NOTE:** Prior to using the transceiver for the first time, the battery pack must be fully charged for optimum life and operation.

① To charge the battery pack while the transceiver is ON, set the following item to “ON” (default).

**MENU** » SET > Function > **Charging (Power ON)**

To charge the battery pack that is attached to the transceiver:

- Connect a power source with a USB cable (User supplied).
- Connect a DC power supply with the supplied DC power cable.

① See Section 13 for details.

To charge the battery pack that is not attached to the transceiver, use the optional rapid charger.

① See the Advanced Manual for details.

### ◇ Battery icon

Icon	Battery status
	The battery is being charged.
	The battery has sufficient charge.
	The battery is exhausted to some extent.
	The battery is nearing exhaustion.
	The battery is almost fully exhausted. ① Immediately charge the battery pack. Otherwise, the icon will soon start blinking, “LOW BATTERY” will be displayed, and the transceiver will automatically turn OFF.
No icon	When a DC power supply (13.8 V DC) is connected, the battery is not being charged because: <ul style="list-style-type: none"> <li>• The battery is completely charged.</li> <li>• “Charging (Power ON)” is set to “OFF.”</li> </ul>

① When the transceiver's display is OFF, the charging indicator lights orange while charging.

#### To display the correct battery status

Select the attached battery pack in the following item. (Default: BP-272)

**MENU** » SET > Function > **Battery Pack Select**

To display the Battery Pack Select dialog every time you attach the battery pack, set the following item to “ON.”

**MENU** » SET > Function > **Battery Pack Confirmation**

**TIP:** Keep the battery terminals clean. It's a good idea to occasionally clean them.

### ◇ Charging time

#### BP-272 (Supplied)

A DC power supply	A USB cable	BC-202IP2 (Optional)
Approximately 2.3 hours*1	Approximately 3.2 hours*1*2	Approximately 2.5 hours

#### BP-307 (Optional)

A DC power supply	A USB cable	BC-202IP2 (Optional)
Approximately 4.3 hours*1	Approximately 5 hours*1*2	Approximately 4 hours

\*1 The transceiver is OFF while charging.

\*2 When using a 2 A output USB port and a cable that is compatible with the rapid charging.

### ◇ Charging with a USB cable

You can charge the battery pack with a USB cable.

#### NOTE:

- You may not be able to charge:
  - Depending on your USB cable or power adapter.
  - When using a USB hub, or connected to a low output USB port.
- Charging time may differ, depending on the USB port.
- To use a mobile device or a PC as an external power source, set the following item to “ON” (default).

**MENU** » SET > Function > **USB Power Input (Phone, Tablet, PC)**

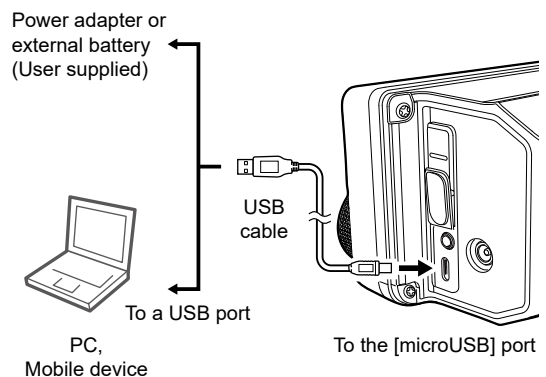

## Front panel

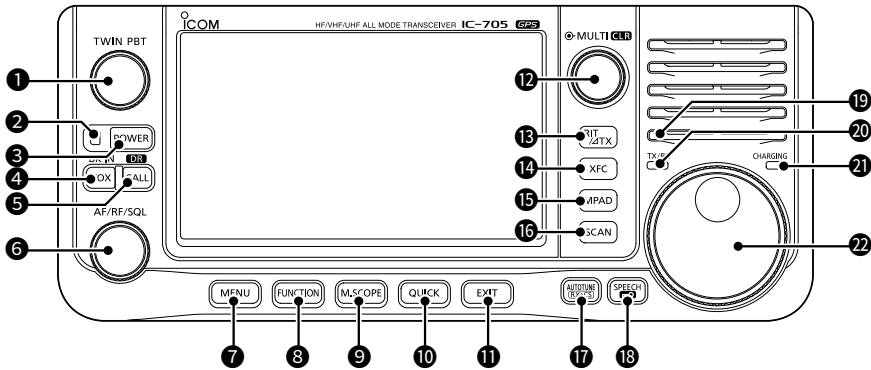

### ① PASSBAND TUNING CONTROL (TWIN PBT) (p. 4-4)

- Push to toggle between “PBT1” and “PBT2,” then rotate to adjust the shift value.
- Hold down for 1 second to clear the PBT settings.

### ② POWER INDICATOR

- Lights green while the transceiver is ON.
- Blinks green while the transceiver is in the Screen Saver mode.
- Lights orange while the display is OFF by pushing **POWER**.
- Blinks orange while the transceiver is in the Standby mode.

### ③ POWER KEY (POWER) (p. 3-1)

- Push to turn ON the transceiver.
- Hold down 1 second to turn OFF the transceiver.

### ④ VOX/BREAK-IN KEY (VOX) / (BK-IN)

Push to turn the VOX function and the Break-in function in the CW mode (p. 4-12) ON or OFF.

### ⑤ CALL/DR FUNCTION KEY (CALL) / (DR)

- Push to toggle between the Call channel mode and the VFO/Memory modes. (p. 3-1)
- Hold down for 1 second to turn the DR function ON or OFF.

### ⑥ VOLUME/RF GAIN/SQUELCH CONTROL (AF/RF/SQL)

- Rotate to adjust the audio output level. (p. 3-1)
- Push to display the setting menu, then rotate to adjust the RF gain (sensitivity) or squelch threshold levels. (p. 3-8)

### ⑦ MENU KEY (MENU) (p. 2-7)

Push to open the MENU screen.

### ⑧ FUNCTION KEY (FUNCTION) (p. 2-6)

Push to open the FUNCTION screen.

### ⑨ MINI SCOPE KEY (M.SCOPE) (p. 5-2)

- Push to display the Mini scope screen.
- Hold down for 1 second to display the Spectrum scope screen.

### ⑩ QUICK KEY (QUICK) (p. 2-7)

Push to open the QUICK MENU screen.

### ⑪ EXIT KEY (EXIT)

Push to exit a setting screen or return to the previous screen.

### ⑫ MULTI-FUNCTION CONTROL (MULTI) / (CLR)

- Push to open the Multi-function menu for various adjustments. (p. 2-7)
- Rotate to adjust the value that is assigned to (MULTI). (p. 2-8)

### ⑬ RIT/ΔTX KEY (RIT/ΔTX)

- Push to turn the Receiver Incremental Tuning (RIT) function (p. 4-2) or the ΔTX function ON or OFF.
- Hold down to toggle between the RIT function and the ΔTX function.





Front panel

- 14 TRANSMIT FREQUENCY CHECK KEY** 

  - In the Split or Duplex mode, holding the key down enables you to monitor the transmit frequency.
  - In the Simplex mode, holding the key down temporarily opens the squelch and cancels the noise reduction function.
  - ① In the DV mode, holding the key down enables you to monitor signals in the FM or DV mode, depending on the Digital Monitor setting.
- 15 MEMO PAD KEY** 

  - Push to sequentially call up the contents in the Memo Pads.
  - Hold down for 1 second to save the displayed contents into the Memo Pad.
- 16 SCAN KEY** 

  - Push to display the SCAN SELECT screen.
  - Hold down for 1 second to start the previously selected scan.
- 17 AUTO TUNE/RX CALL SIGN CAPTURE KEY**  

  - In the CW mode, pushing the key automatically tunes the operating frequency to a close-by CW signal. (p. 4-13)
  - In the DV mode, push to display the RX History list, or hold down for 1 second to capture the latest received call sign (station or repeater) as a temporary call destination.
- 18 SPEECH/LOCK KEY** 

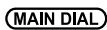
  - Push to announce the operating frequency or mode.
  - Hold down for 1 second to electronically lock **MAIN DIAL**. (p. 3-8)
- 19 AMBIENT LIGHT SENSOR**  
 Used to automatically adjust the display's backlight brightness.  
 ① **DO NOT** cover the sensor.
- 20 TX/RX INDICATOR**  
 Lights red while transmitting, and lights green while receiving.
- 21 CHARGING INDICATOR** (p. 1-2)  
 Lights orange while charging when the transceiver's display is OFF.
- 22 MAIN DIAL** 

  - Rotate to change the operating frequency.

Bottom panel

You can attach a third party mounting base using screw holes\* on the bottom panel.  
 \* AMPS hole pattern

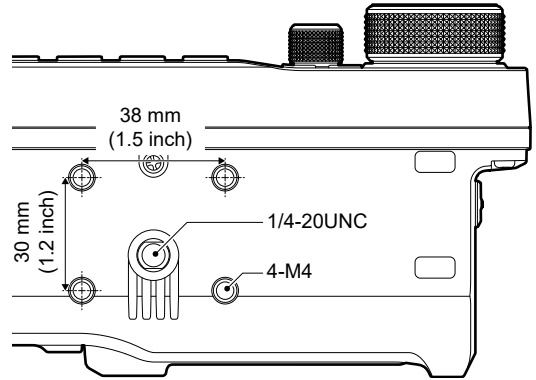

### Side panels

#### Right side panel

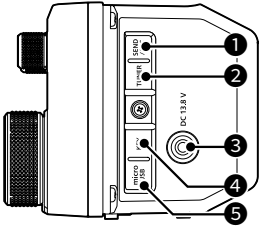

#### Left side panel

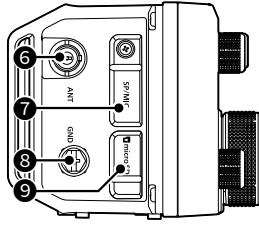

#### 1 SEND/ALC JACK [SEND/ALC] (p. 13-2)

Connect to control transmit with non-Icom external units or the ALC output jack of a non-Icom linear amplifier.

#### 2 TUNER JACK [TUNER]

Accepts the control cable from an external antenna tuner with a 3.5 mm (1/8 inch) stereo plug.

#### 3 DC POWER JACK [DC 13.8 V] (p. 13-1)

Accepts 13.8 V DC through the supplied DC power cable.

#### 4 KEY JACK [KEY] (p. 13-2)

Connects to a straight key, paddle, an external electronic keyer, or an external keypad with a 3.5 mm (1/8 inch) stereo plug.

#### 5 microUSB PORT (TYPE-B) [microUSB] (p. 13-3)

Connects to an external power source, a PC, or other USB device.

#### 6 ANTENNA CONNECTOR [ANT] (p. 13-3)

Connect to a 50 Ω Type BNC coax connector.

#### 7 SPEAKER-MICROPHONE CONNECTOR [SP/MIC] (p. 13-3)

Connect a speaker microphone or headset. (SP: 3.5 mm (1/8 inch), MIC: 2.5 mm)

① Confirm that the transceiver is OFF before connecting or disconnecting optional equipment.

#### 8 GROUND TERMINAL [GND] (p. 13-2)

Connect to ground to prevent electrical shocks, TVI, BCI, and other problems.

#### 9 microSD CARD SLOT [microSD CARD] (p. 6-1)

Insert a microSD card (user supplied).

### Speaker Microphone

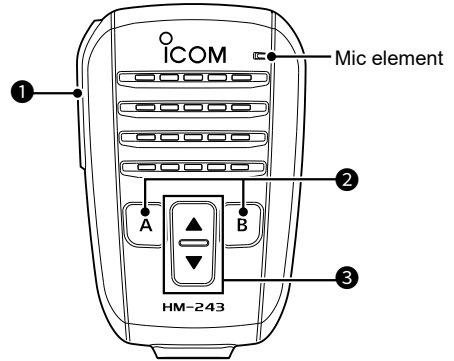

#### 1 [PTT] SWITCH

Hold down to transmit, release to receive.

**NOTE:** To maximize the readability of your signal, hold the microphone 5 to 10 cm (2 to 4 inches) from your mouth, and then speak at your normal voice level.

#### 2 [A] KEY

Push to activate the assigned function of the [A] key. (Default: Home CH)

#### [B] KEY

Push to activate the assigned function of the [B] key. (Default: VFO/MEMO)

#### 3 [▲]/[▼] (UP/DOWN) KEYS

- Push to change the operating frequency or Memory channel.
- Hold down to continuously change the frequency or Memory channel.

**TIP:** You can change the assigned function of the [▲], [▼], [A], and [B] keys in the following item.

**MENU** » **SET > Function > Remote MIC Key**

## Touch screen display

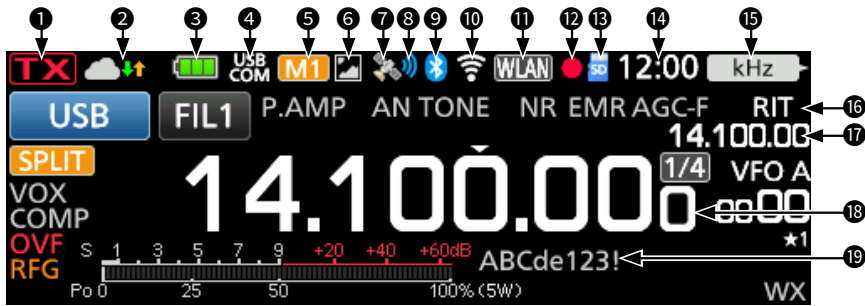

### 1 TX STATUS INDICATOR

Displays the transmit status.

- **TX** is displayed while transmitting.
- **TX** (with a dotted line) is displayed when the selected frequency is outside of the band edge frequency range. (p. 3-5)
- Displayed in orange when the transceiver is in the Terminal mode.
- **TX** (Grayed out) is displayed when transmission is inhibited.

### 2 INTERNAL GATEWAY/TUNE ICON TUNE

Displays the communication status while using the Internal Gateway function.  
Displays the antenna tuning status.

### 3 BATTERY ICON (p. 1-2)

Displays the charge status of the attached battery pack.

Touch the icon to display the VOLTAGE screen. (p. 8-23)

- ① No icon is displayed while using an external power source.
- ①  is displayed while charging the battery pack.

### 4 USB CONNECTION INDICATOR

Displayed when an external USB device is connected through a USB cable.

### 5 M1~M8/T1~T8 ICONS

- “M1”~“M8” is displayed when “External Keypad” on the CONNECTORS screen is set to “ON,” and you are using the Memory Keyer function.
- “T1” ~ “T8” is displayed when using the Voice TX memory.

### 6 PICTURE SHARE ICON

Displayed when the Share Pictures function is ON.

### 7 GPS ICON (p. 7-1)

Displays the status of the GPS receiver.  
Touch the icon to display the GPS INFORMATION screen.

### 8 GPS ALARM ICON

Displayed when the GPS Alarm function is ON.

### 9 Bluetooth® ICON

Displayed when a Bluetooth device is connected.

### 10 WIRELESS LAN ICON

Displays the WLAN signal strength while connected to a wireless network.

### 11 NETWORK CONTROL ICON

Displayed while accessing the transceiver using the optional RS-BA1, for Remote control operation.

### 12 VOICE RECORDER ICONS

Displayed while recording or pausing using the Voice recorder.

### 13 SD CARD ICON (p. 6-1)

Displayed when a microSD card is inserted, and blinks while accessing the card.

### 14 CLOCK READOUT (p. 9-1)

Displays the current local time.  
Touch the readout to display both the current local time and UTC time.

### 15 FUNCTION INDICATOR FOR MULTI-FUNCTION CONTROL (p. 2-8)

Displays the function that is assigned to .

### 16 RIT/ΔTX ICON

Displayed when the Receive Increment Tuning (RIT) (p. 4-2) or ΔTX function is ON.

### 17 RIT/ΔTX/SPLIT/DUPLEX FREQUENCY READOUT

- Displays the shift offset frequency for the RIT or ΔTX functions.
- Displays the shift frequency for the Duplex function or the split frequency.

### 18 FREQUENCY READOUT

Displays the operating frequency.

### 19 MEMORY NAME

Displays the Memory name, if entered.

### Touch screen display

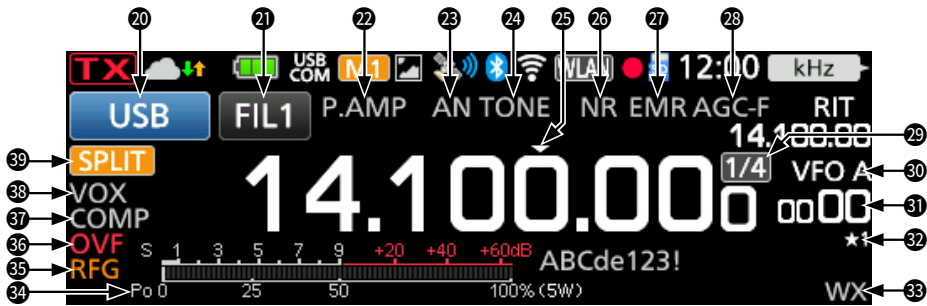

- ⑳ MODE INDICATOR** USB (p. 3-2)  
Displays the selected operating mode.
- ㉑ IF FILTER INDICATOR** FIL1 (p. 4-5)  
Displays the selected IF filter number.  
① A dot “.” is displayed on the IF Filter Indicator when you change the IF passband width.
- ㉒ PREAMPLIFIER/ATTENUATOR ICONS** (p. 4-1)  
Displayed when one of the Preamplifiers (P.AMP) or the Attenuator (ATT) is ON.
- ㉓ NOTCH INDICATOR** (p. 4-6)  
Displayed when the Auto Notch (AN) or Manual Notch (MN) function is ON.
- ㉔ NOISE BLANKER/TONE/DIGITAL SQUELCH ICONS** (p. 4-7)  
Displayed when the Noise Blanker (NB), tone, or digital squelch functions is ON.
- ㉕ QUICK TUNING ICON** (p. 3-3)  
Displayed when the Quick Tuning Step function is ON.
- ㉖ NOISE REDUCTION/AUTO TUNE ICONS** (pp. 4-8, 4-13)  
Displayed when the Noise Reduction (NR) or Auto Tuning function is ON.
- ㉗ EMR/BK/AUTO REPLY/PACKET LOSS ICONS**  
Displayed when the Enhanced Monitor Request (EMR), Break-in (BK), Automatic Reply () function is ON, or “L” is displayed when packet loss has occurred.
- ㉘ AGC ICON** (p. 4-3)  
Displayed while the Auto Gain Control (AGC) is ON.
- ㉙ ¼ ICON** (p. 3-3)  
Displayed while the 1/4 Tuning function is ON.
- ㉚ VFO/MEMORY ICONS** (p. 3-1)  
Displays “VFO A” or “VFO B” when the VFO mode is selected, and displays “MEMO” when the Memory mode is selected.
- ㉛ MEMORY CHANNEL READOUT**  
Displays the selected memory channel number.
- ㉜ SELECT MEMORY CHANNEL ICON**  
Indicates that the displayed memory channel is assigned as a Select Memory channel (★1~★3).
- ㉝ WEATHER ALERT ICON**  
Displayed when the Weather Alert function is ON. (Only the USA version)
- ㉞ MULTI-FUNCTION METER** (p. 3-9)  
Displays various values and levels, depending on the function that you selected.
- ㉟ RF GAIN ICON** (p. 3-8)  
Displayed when the RF gain is reduced.
- ㊱ OVF ICON** (p. 3-8)  
Displayed when an excessively strong signal is received.
- ㊲ SPEECH COMPRESSOR ICON** (p. 4-9)  
Displayed when the Speech Compressor function is ON.
- ㊳ BK-IN/F-BKIN/VOX INDICATORS** (p. 4-12)  
Displayed when the Semi Break-in (BK-IN), Full Break-in (F-BKIN), or VOX function is ON.
- ㊴ SPLIT/DUPLEX ICONS**  
Displayed when the Split or Duplex (DUP- / DUP+) function is ON.

Touch screen display

◇ FUNCTION screen

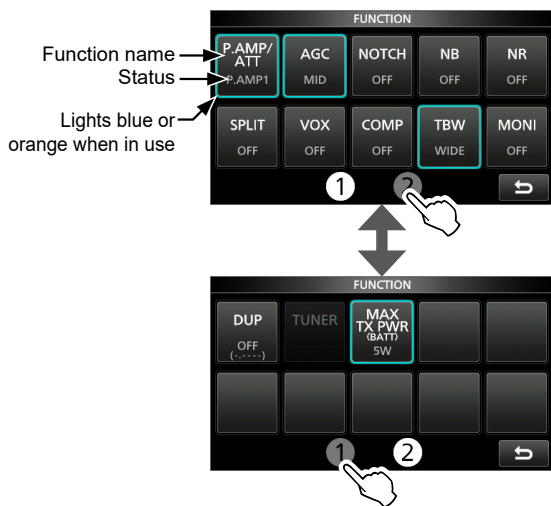

- Push **FUNCTION** to open the FUNCTION screen in the selected mode.
  - ① To close the FUNCTION screen, push **EXIT**.
  - ① Touching [①] or [②] at the bottom of the screen selects FUNCTION screen 1 or 2.

FUNCTION screen list

- \*1 Touch for 1 second to select the function.
- \*2 Touch for 1 second to open its function menu.
- \*3 Touch for 1 second to turn ON the Quick Split function.
- \*4 Touch for 1 second to start manual tuning.

P.AMP/ATT	P.AMP	AGC*2	NOTCH*2
OFF	OFF	FAST	OFF
P.AMP1	ON	MID	AN
P.AMP2		SLOW	MN
ATT*1			
NB*2	NR*2	SPLIT*3	VOX*2
OFF	OFF	OFF	OFF
ON	ON	ON	ON
BKIN*2	TONE*2		
OFF	OFF	DTCS (T)	
BKIN	TONE	TONE (T)/DTCS (R)	
F-BKIN	TSQL	DTCS (T)/TSQL (R)	
	DTCS	TONE (T)/TSQL (R)	
D.SQL*2	COMP	TBW	1/4
OFF	OFF	WIDE	OFF
DSQL	ON	MID	ON
CSQL		NAR	
MONI*2	DUP*2	TUNER*4	MAX TX PWR
OFF	OFF	OFF	0.5 W
ON	DUP-	ON	1 W
	DUP+		2.5 W
			5 W
			10 W

## 2 PANEL DESCRIPTION

### Touch screen display

#### ◇ MENU screen



- Push **MENU** to open the MENU screen in the selected mode.
  - ① To close the MENU screen, push **EXIT**.
  - ① Touching [①] or [②] at the bottom of the screen selects MENU screen 1 or 2.

#### ◇ QUICK MENU

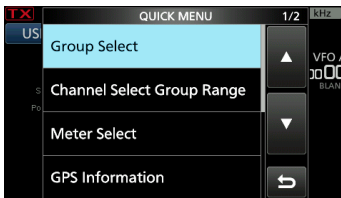

- Push **QUICK** to open the QUICK MENU screen.

#### ◇ Multi-function menus

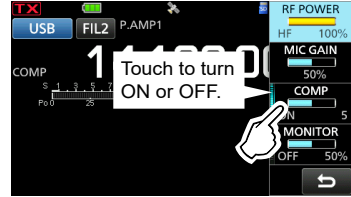

- Open the Multi-function menu by pushing **MULTI** (Multi-function control).
- Open special menus by holding down **VOX** or **BK-IN** for 1 second.
- While the Multi-function menu is open, touch the desired item and rotate **MULTI** to set the desired value.

#### Multi-function menu items

- \*1 Touch the edge to turn the function ON or OFF, or to adjust the selected item.
- \*2 Touch the item for 1 second to adjust by rotating **MULTI**, even when the Multi-function menu is closed.

SSB	SSB-D	CW	RTTY
RF POWER* <sup>2</sup>	RF POWER* <sup>2</sup>	RF POWER* <sup>2</sup>	RF POWER* <sup>2</sup>
MIC GAIN* <sup>2</sup>	MIC GAIN* <sup>2</sup>	KEY SPEED* <sup>2</sup>	TPF* <sup>1</sup>
COMP* <sup>1*2</sup>		CW PITCH* <sup>2</sup>	
MONITOR* <sup>1*2</sup>	MONITOR* <sup>1*2</sup>		MONITOR* <sup>1*2</sup>
AM	FM/WFM	DV	NB
RF POWER* <sup>2</sup>	RF POWER* <sup>2</sup>	RF POWER* <sup>2</sup>	LEVEL* <sup>2</sup>
MIC GAIN* <sup>2</sup>	MIC GAIN* <sup>2</sup>	MIC GAIN* <sup>2</sup>	DEPTH* <sup>2</sup>
			WIDTH* <sup>2</sup>
MONITOR* <sup>1*2</sup>	MONITOR* <sup>1*2</sup>	MONITOR* <sup>1*2</sup>	
NR	NOTCH	VOX	BK-IN
LEVEL* <sup>2</sup>	POSITION* <sup>2</sup>	GAIN* <sup>2</sup>	DELAY* <sup>2</sup>
	WIDTH* <sup>1</sup>	ANTI VOX* <sup>2</sup>	
		DELAY* <sup>2</sup>	
		VOICE DELAY* <sup>1</sup>	

## Multi-function dial

When the Multi-function menu is closed, **MULTI** can be enabled to adjust functions by pushing **RIT/ΔTX** or touching the item for 1 second on the Multi-function menus.

The function is displayed in the upper right corner of the screen.

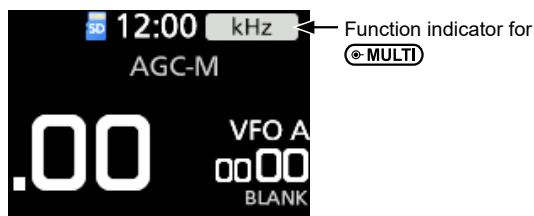

\* On the Multi-function menus, touch the item for 1 second to assign the function to **MULTI**.

Indicator	Action	
RIT	Rotate	Adjusts the RIT frequency.
	Hold down	Clears the RIT frequency.
ΔTX	Rotate	Adjusts the ΔTX frequency.
	Hold down	Clears the ΔTX frequency.
kHz	Changes the operating frequency in kHz steps. (VFO mode only) ① To assign this function, hold down <b>MULTI</b> for 1 second when the RIT or ΔTX function is OFF.	
M-CH	Selects Memory channels. (Memory mode and Call channel mode only) When using the DR function, selects an individual station or preset repeater. ① To assign this function, hold down <b>MULTI</b> for 1 second when the RIT or ΔTX function is OFF.	
RF PWR*	Adjusts the transmit output power.	
MIC G*	Adjusts the microphone gain.	
COMP*	Adjusts the Speech Compressor level.	
MONI*	Adjusts the audio level for the Monitor function.	
SPEED*	Adjusts the Keying speed.	
PITCH*	Adjusts the CW pitch.	
NB LEV*	Adjusts the Noise Blanker level.	
NB DEP*	Adjusts the DEPTH (Noise attenuation level).	
NB WID*	Adjusts the WIDTH (Blanking duration time).	
NR LEV*	Adjusts the Noise Reduction level.	
NOTCH*	Adjusts the Notch filter frequency.	
VOX G*	Adjusts the VOX gain.	
A-VOX*	Adjusts the ANTI VOX level.	
VOX D*	Adjusts the VOX delay time.	
BKIN D*	Adjusts the Break-in delay time.	

## When first applying power

Before turning ON your transceiver for the first time, make sure all connections are correctly made.

**TIP:** When you turn OFF the transceiver, it memorizes the current settings. Therefore, when you turn ON the transceiver again, it restarts with the same settings.

## Selecting the mode

### VFO mode

Set the desired frequency by rotating **(MAIN DIAL)**.

### Memory mode

Enter contents into the desired channel in the MEMORY list.

### Call channel mode

Call channels (or Main channel) are used to call on an often used frequency. Two Call channels are assigned on each of the 144 and 430 bands.

### Weather channel mode

Weather channels are used to hear weather channels from the National Oceanographic and Atmospheric Administration (NOAA) broadcasts.

① Selectable in only the USA version.

② See the Advanced Manual for details.

## Selecting the VFO, Memory, or Call channel mode

① To select the Call channel mode, select the 144 or 430 band.

1. Touch the VFO/MEMORY icon.

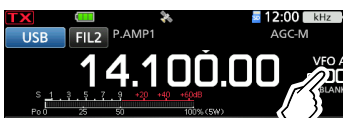

• Opens the VFO/MEMORY screen.

2. Touch [VFO], [MEMO], or [CALL].



① You can also select the Call channel mode by pushing **(CALL)**.

## Turning power ON or OFF

- To turn ON the transceiver, push **(POWER)**.
- To turn OFF the transceiver, hold down **(POWER)** for 1 second until "POWER OFF..." is displayed.

## Adjusting the volume level

Rotate **(AF/RF/SQL)** to adjust the volume level.

## Using the VFO mode

The IC-705 has 2 Variable Frequency Oscillators (VFO), "A" and "B." Having 2 VFOs is convenient to quickly select 2 frequencies, or for split frequency operation (p. 4-10). You can use either of the VFOs to operate on a frequency and mode.

### ◇ Selecting VFO A or VFO B

1. Touch the VFO/MEMORY icon.
  - Opens the VFO/MEMORY screen.
2. Touch [A/B] to select the VFO A or VFO B.



### ◇ Equalizing VFO A and VFO B

You can set the displayed VFO's frequency to the VFO that is not displayed.

1. Touch the VFO/MEMORY icon.
  - Opens the VFO/MEMORY screen.
2. Touch [A/B] for 1 second.





## Selecting the operating band

Do the following steps to change the operating band.

1. Touch the MHz digits. (Example: 14)

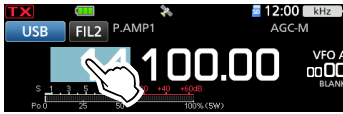

- Opens the BAND STACKING REGISTER screen.

2. Touch a band key. (Example: 21)



- Displays a 21 MHz frequency.

### TIP: About the Band Stacking Register

The Band Stacking Register provides 3 memories for each band. When you change the operating band or the Register, the previously operated frequency and mode are stored.

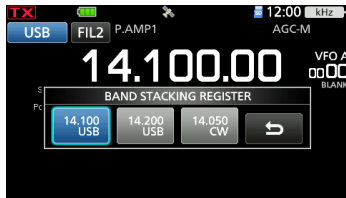

To display the Band Stacking Register contents:

- Touch the band key for 1 second in step 2.
  - Touch the MHz digits for 1 second on the standby screen.
- ① Touch to return to the previous screen.

## Selecting the operating mode

You can select between the SSB (LSB/USB), SSB data (LSB-DATA/USB-DATA), CW, CW reverse, RTTY, RTTY reverse, AM, AM data (AM-DATA), FM, FM data (FM-DATA), WFM, and DV modes.

1. Touch the mode icon (Example: USB).

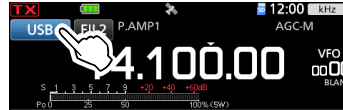

- Opens the MODE screen.
2. On the MODE screen, touch the desired mode key. (Example: CW).



- ① In the SSB, AM, or FM modes, the [DATA] key is displayed.

- ① In the DV mode, the [GPS] key is displayed. When the GPS TX mode is selected, is displayed on the operating mode indicator.

### Operating mode selection list

- ① Touch mode key to select the operating mode.

Mode key	Operating mode	
[SSB]	USB	LSB
[CW]	CW	CW-R
[RTTY]	RTTY	RTTY-R
[AM]	AM	
[FM]	FM	
[DV]	DV	
[WFM]	WFM	
[DATA]	LSB	LSB-D
	USB	USB-D
	AM	AM-D
	FM	FM-D

### Selecting the Data mode

You can operate data communications (SSTV, RTTY (AFSK), PSK31, JT65B, and FT8).

- ① When a data mode is selected, you can mute the input from the microphone.

**MENU** » **SET > Connectors > MOD Input > DATA MOD**

## Setting the frequency

### ◇ Using the Main Dial

1. Select the desired operating band. (p. 3-2)
  2. Rotate **(MAIN DIAL)**.
    - The frequency changes according to the selected Tuning Step.
- ① **TX** is displayed when you select an amateur radio frequency, and **TX** (with a dotted line) is displayed when you select a frequency outside the Ham band, or outside your set Band Edges.

### ◇ About the Tuning Step function

You can set the **(MAIN DIAL)**'s tuning step for each operating mode.

Touch the kHz digits to turn the Tuning Step function ON or OFF.

- ① The Tuning Step function's icon "▼" is displayed above the 1 kHz digit.

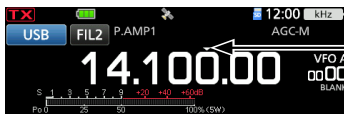
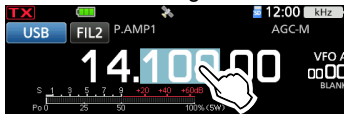

The Tuning Step function is ON.

### ◇ Changing the Tuning Step

When the Tuning Step function is ON, you can change the tuning steps for each operating mode.

1. Select the desired operating mode. (p. 3-2)  
(Example: USB)
2. Touch the kHz digit for 1 second.

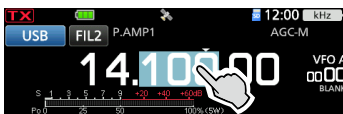

- Opens the TS (SSB) screen.

3. Touch the desired tuning step.  
(Example: 0.1 k)



- The tuning step is set, and returns to the previous screen.

### ◇ About the 1 Hz step Fine Tuning function

You can use the minimum tuning step of 1 Hz for fine tuning in the SSB, CW, and RTTY modes.

Touch the Hz digits for 1 second to turn the Fine Tuning function ON or OFF.

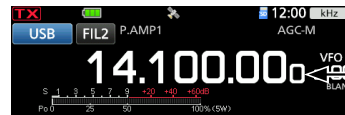
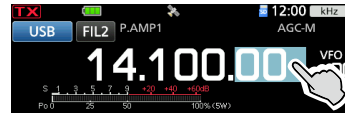

The 1 Hz digit is displayed.

### ◇ About the 1/4 Tuning function

#### SSB-D, CW, and RTTY modes

With the Tuning Function OFF, turn ON the 1/4 Tuning function to reduce the tuning speed to 1/4 of the normal speed, for finer tuning.

1. Push **(FUNCTION)**.
  - Opens the FUNCTION screen.
2. Touch [1/4].

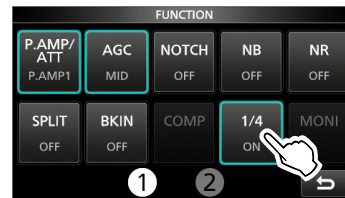

3. Push **(EXIT)**.



1/4 Tuning function is ON.

### ◇ About the Auto Tuning Step function

The tuning step automatically changes, depending on the rotation speed of **(MAIN DIAL)**.

- ① You can change the Auto Tuning Step function settings in the following menu. (p. 8-15)

**(MENU)** » **SET > Function > MAIN DIAL Auto TS**

Setting the frequency

◇ Directly entering a frequency

You can set the frequency without rotating **(MAIN DIAL)** by directly entering it using the keypad.

Entering the operating frequency

1. Touch the MHz digits. (Example: 14)
  - Opens the BAND STACKING REGISTER screen.
2. Touch [F-INP].



- Opens the F-INP screen.
3. Start entry with the most significant digit.



- ① To clear the entry, touch [CE].
- ① To clear the entry and return to the previous screen, push **(EXIT)**.

4. Touch [ENT] to set the entered frequency. Closes the F-INP screen.

- ① If you touch [ENT] when the digits under 100 kHz are not entered, "0" will be automatically entered into the digits that are blank.

Entry examples

- 14.025 MHz: [1], [4], [ $\bullet(-)$ ], [0], [2], [5], [ENT]
- 18.0725 MHz: [1], [8], [ $\bullet(-)$ ], [0], [7], [2], [5], [ENT]
- 730 kHz: [0], [ $\bullet(-)$ ], [7], [3], [ENT]
- 7.000 MHz: [7], [ENT]
- 5.100 MHz: [5], [ $\bullet(-)$ ], [1], [ENT]
- 144.680 MHz: [1], [4], [4], [ $\bullet(-)$ ], [6], [8], [ENT]
- Changing from 21.280 MHz to 21.245 MHz: [ $\bullet(-)$ ], [2], [4], [5], [ENT]

- ① Touching [ $\bullet(-)$ ] first enters the same MHz digits as the operating frequency.

Entering the Split Frequency Offset

1. Touch the MHz digits. (Example: 14)
  - Opens the BAND STACKING REGISTER screen.
2. Touch [F-INP].

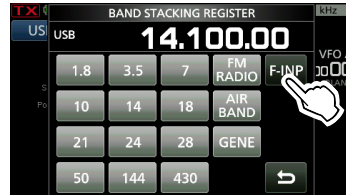

- Opens the F-INP screen.
3. Enter the Split Frequency Offset.



[SPLIT] or [-SPLIT] is displayed.

Information

- If you want the minus shift direction, touch [ $\bullet(-)$ ].
  - Enter the offset between -9.999 MHz and +9.999 MHz (1 kHz steps).
  - To clear the entry, touch [CE].
  - To clear the entry and return to the previous screen, push **(EXIT)**.
  - After entering, the Split function is automatically turned ON.
4. To save the entry, touch [SPLIT] or [-SPLIT].
    - Closes the F-INP screen.

Entry examples

- 5 kHz: [5], [SPLIT]
- -10 kHz: [ $\bullet(-)$ ], [1], [0], [-SPLIT]

**NOTE:** If the entered operating frequency is out of an amateur band's frequency range, the transmit frequency is automatically set to the band edge frequency.

## Setting the frequency

◇ Directly entering a frequency (Continued)

### Selecting a Memory channel by number

1. Select the Memory mode. (p. 3-1)
2. Select a memory group.
  - ① To select a memory group, touch the VFO/MEMORY icon, and then touch [GROUP].
3. Touch the MHz digits. (Example: 14)
  - Opens the BAND STACKING REGISTER screen.
4. Touch [F-INP].



- Opens the F-INP screen.
5. Enter a Memory channel number. (Example: 2)



- ① If the Call channel group is selected, enter between “0” and “3.”
    - 0: 144 C1
    - 1: 144 C2
    - 2: 430 C1
    - 3: 430 C2
6. Touch [MEMO] to set the memory channel of the entered number.
    - Closes the F-INP screen.
    - The selected memory channel contents are displayed.

### ◇ Band Edge Beep

You will hear a Band Edge Beep and **TX** (with a dotted line) will be displayed when you tune into or out of an amateur band’s frequency range.

① You can change the Band Edge Beep settings in the following menu.

**MENU** » **SET > Function > Band Edge Beep**

① If “Beep Level” is set to “0%,” no beep sounds.

**MENU** » **SET > Function > Beep Level**

### ◇ Entering a Band Edge

When “ON (User)” or “ON (User) & TX Limit” is selected on the “Band Edge Beep” screen, you can enter a total of 30 band edge frequency pairs.

#### ① Information

- Initially, all Ham band frequencies are entered. Therefore, you must first edit or delete them, and then insert a new line to enter a new band edge.
- You cannot enter an overlapping frequency, or a frequency that is out of the preset Ham band frequencies.
- Band edges are entered from the lower frequency first.
- These settings are easy with the CS-705. (p. 12-1)

1. Open the “Band Edge Beep” screen.

**MENU** » **SET > Function > Band Edge Beep**

2. Touch “ON (User)” or “ON (User) & TX Limit.”

① If you set “ON (User) & TX Limit,” you can limit transmission to within the entered frequency range.

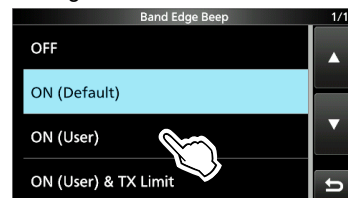

3. Touch “User Band Edge.”

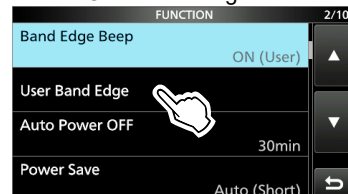

- Opens the “User Band Edge” screen.

Setting the frequency

**Editing a Band Edge**

You can edit a band edge entered as a default, or change the band edge frequencies.

1. Open the “User Band Edge” screen.
2. Touch the band edge you want to edit.  
(Example: 6: 14.000.000 – 14.350.000 MHz)

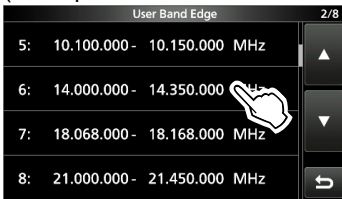

3. Edit the lower band edge frequency, then touch [ENT]. (Example: 14.)  
Entry example: [\*] [1] [ENT]



4. Edit the upper band edge frequency, then touch [ENT]. (Example: 14.25)  
Entry example: [\*] [2] [5] [ENT]

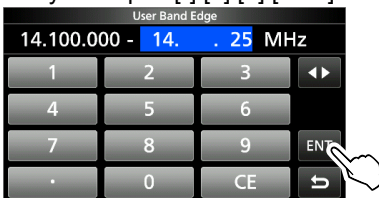

- The edited band edge is saved, and returns to the previous screen.

**TIP:** You can also edit the frequency by rotating **(MAIN DIAL)** or **(MULTI)**.

**Deleting a Band Edge**

You can delete band edges you no longer need.

1. Open the “User Band Edge” screen.
2. Touch the desired band edge to delete for 1 second.  
(Example: 1: 1.800.000 – 1.999.999 MHz)

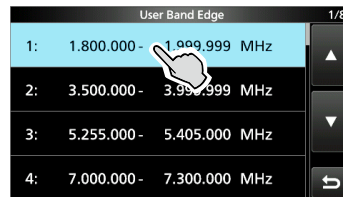

3. Touch “Delete.”

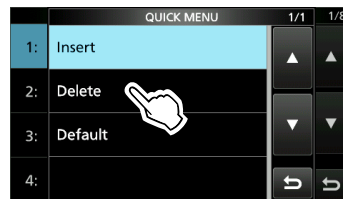

- The selected band edge is deleted, and returns to the previous screen.

## Setting the frequency

### ◇ Entering a Band Edge (Continued)

#### Entering a new Band Edge

You can enter new Band Edge frequencies into a blank band edge line.

1. Open the “User Band Edge” screen.
2. Touch a blank band. (Example: 12)

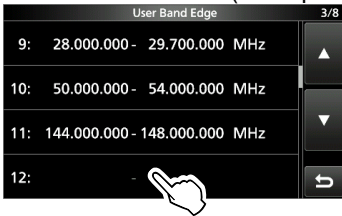

3. Enter the lower band edge frequency, then touch [ENT]. (Example: 433.)  
Entry example: [4] [3] [3] [ENT]



4. Enter the upper band edge frequency, then touch [ENT]. (Example: 439.9)  
Entry example: [4] [3] [9] [.] [9] [ENT]

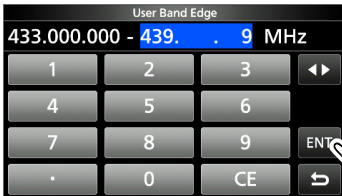

- The entered band edge is saved, and returns to the previous screen.

#### Inserting a Band Edge

You can insert a new Band Edge line, and enter new band frequencies, between two entered band edges.

1. Open the “User Band Edge” screen.
2. Touch the band edge you want to insert a new band edge above, for 1 second.  
(Example: 1: 3.500.000 – 3.999.999 MHz)

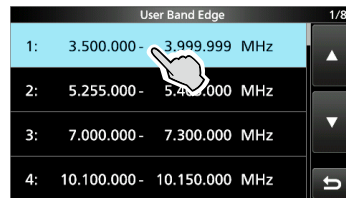

① The new band edge will be inserted above the selected band edge.

3. Touch “Insert.”

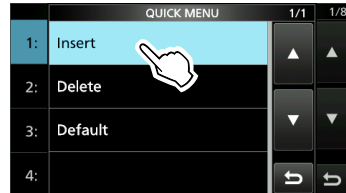

4. Enter the lower band edge frequency then touch [ENT]. (Example: 1.85)  
Entry example: [1] [.] [8] [5] [ENT]

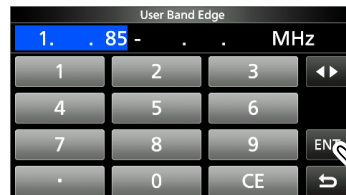

5. Enter the upper band edge frequency, then touch [ENT]. (Example: 1.95)  
Entry example: [.] [9] [5] [ENT]

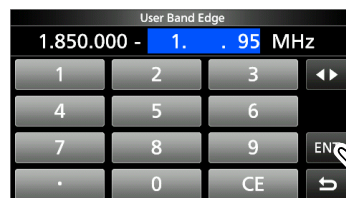

- The entered band edge is saved, and returns to the previous screen.

Setting the frequency

**Resetting all band edges to presets**

The steps below will reset all the band edges to their initial settings. All entered settings will be deleted.

1. Open the “User Band Edge” screen.
2. Touch any band edge for 1 second.

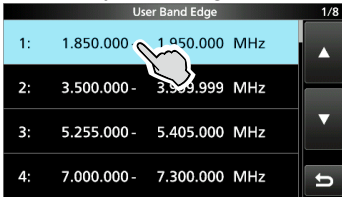

3. Touch “Default.”



4. Touch [YES].

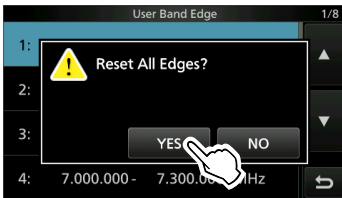

- All the band edges reset to the initial settings.

**Dial Lock function**

The Dial Lock function prevents frequency changes caused by accidentally moving (MAIN DIAL).  
 ① This function electronically locks the dial.

Hold down **[SPEECH]** for 1 second to turn the Dial Lock function ON or OFF.

- During Split Frequency operation, the Split Lock function may be turned ON. (p. 8-15)

**[MENU]** » **SET > Function > Lock Function**

**RF gain and SQL level**

1. Push **(AF/RF/SQL)**.
2. Touch an item to adjust. (Example: RF GAIN)

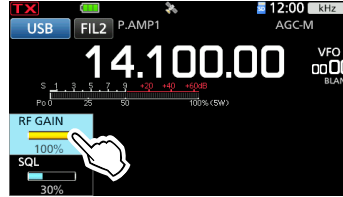

3. Rotate **(AF/RF/SQL)**.

**RF gain**

You can adjust the receive sensitivity.

If a strong interfering signal is received, rotate **(AF/RF/SQL)** counterclockwise to reduce the RF gain.

- ① “RFG” is displayed when the RF gain is reduced.
- ① If a strong signal is received and “OVF” (Overflow) is displayed, reduce the RF gain until “OVF” disappears.

**Squelch (SQL) level**

There are 2 types of SQL levels, depending on the operating mode.

• **Noise squelch**

Rotate **(AF/RF/SQL)** until the noise just disappears and the TX/RX indicator goes OFF.

- ① Activates when the squelch level is set to between 30% and 50% in the FM, AM,\* or DV mode.

\* Only when the AIR band is selected.

• **S-meter squelch**

The S-meter squelch disables the audio output from the speaker or headphones when the received signal is weaker than the specified S-meter squelch level.

Rotate **(AF/RF/SQL)** clockwise to increase the S-meter threshold level.

- ① Activates when the squelch level is set to between 50% and 100% in any mode.

## Meter display

### ◇ Meter display selection

You can display one of the 6 different transmit parameters (Po, SWR, ALC, COMP, Vd, and Id) for your convenience.

Touch the parameter to display one of the meters.

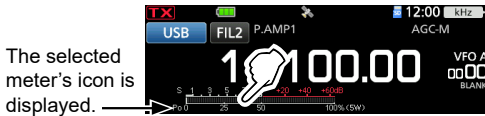

### ◇ Multi-function meter

You can simultaneously display all the parameters.

① The TEMP meter is also displayed on the Multi-function meter.

Touch the currently displayed parameter for 1 second to display the Multi-function meter.

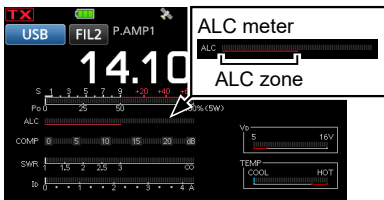

When the Vd meter reads on the red under line or below, the output power may decrease, or transceiver power may be shut down.

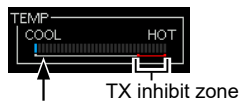

Displays the temperature of the final amplifier MOS-FETs.

- S:** Displays the receiving signal strength level.
- Po:** Displays the relative RF output power.
- SWR:** Displays the SWR of the antenna at the frequency.
- ALC:** Displays the ALC level. When the meter movement shows the input signal level exceeds the allowed level, the ALC limits the RF power. In such cases, decrease the microphone gain level.
- COMP:** Displays the compression level when the speech compressor is used.
- Vd:** Displays the drain voltage of the final amplifier MOS-FETs.
- Id:** Displays the drain current of the final amplifier MOS-FETs.
- TEMP:** Displays the temperature of the final amplifier MOS-FETs.

## Adjusting the transmit output power

Before transmitting, monitor your selected operating frequency to make sure you do not cause interference to other stations on the same frequency. It is good amateur practice to listen first, and then, even if nothing is heard, ask if the frequency in use once or twice, before you start operating.

1. Select the operating mode. (p. 3-2)  
(Example: RTTY)
2. Touch the meter to display the Po meter.  
(p. 3-9)

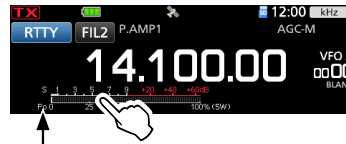

"Po" is displayed.

3. Push **[MULTI]** to open the Multi-function menu.
4. Hold down **[PTT]**.
  - The TX/RX indicator lights red, and **TX** is displayed.
  - The Po meter level changes according to your voice level in the SSB mode. It becomes the S-meter while receiving.
5. Touch **[RF POWER]**, and rotate **[MULTI]** to adjust the transmit output power between 0 and 100% (in 1% steps).

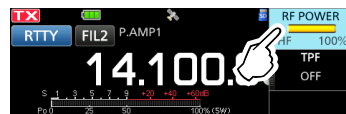

- ① In the AM mode, the maximum transmit output power is a quarter of the other mode's output.
- ① The transmit output power is limited to the maximum transmit output power.

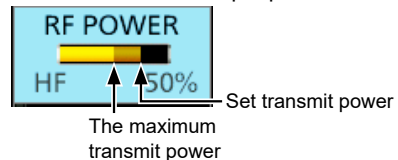

6. Release **[PTT]**.
  - Returns to receive.



## Setting the maximum transmit power

The maximum transmit power depends on the power source.

- When using an external DC power supply (13.8 V DC): 10 W
  - When using the battery pack: 5 W
- ① When connecting an external power source with a USB cable, the battery pack is used as a power source while transmitting.

1. Push **[FUNCTION]** to open the FUNCTION screen.
2. Touch ② at the bottom of the screen.
3. Touch **[MAX TX PWR]**.



- Opens the MAX TX POWER screen.
4. Touch the desired maximum transmit power.
    - ① In the AM mode, the maximum transmit output power is a quarter of the other mode's output.
  5. To close the FUNCTION screen, push **[MULTI]**.
    - The maximum transmit power is displayed on the Po meter.
- ① You can also change the maximum transmit power in the SET mode. (p. 8-4)

## Adjusting the microphone gain

1. Set the operating band and mode to SSB, AM, FM, or DV. (p. 3-2)
2. Push **[MULTI]** to open the Multi-function menu.
3. Hold down **[PTT]**.
4. Touch **[MIC GAIN]**, and rotate **[MULTI]** to adjust the microphone gain.

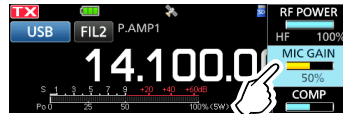

### ① Information

- Hold the microphone 5 to 10 cm (2 to 4 inches) from your mouth, then hold down **[PTT]** on the microphone and speak at your normal voice level.
  - In the SSB mode, touch the TX meter to select the ALC meter, and rotate **[MULTI]** to adjust the microphone gain until the meter reading swings between 30 to 50% of the ALC scale.
  - In the AM, FM, or DV mode, check the audio clarity with another station, or use the Monitor function (p. 4-2).
5. Release **[PTT]**.
    - Returns to receive.

## Preamplifiers

The preamp amplifies received signals in the receiver front end to improve the signal-to-noise ratio and sensitivity. A preamp is used when receiving weak signals.

① Each band memorizes the Preamp setting.

1. Push **[FUNCTION]**.
  - Opens the FUNCTION screen.
2. Touch **[P.AMP/ATT]** or **[P.AMP]**.
  - ① In the HF or 50 MHz band, touching **[P.AMP/ATT]** selects P.AMP1, P.AMP2, or OFF.
  - ① In the 144 or 430 MHz band, touching **[P.AMP]** turns this function ON or OFF



3. To close the FUNCTION screen, push **[EXIT]**.

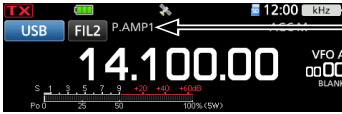

Displayed when a preamp is ON.

HF 50 MHz	P.AMP 1	Wide dynamic range preamplifier. It is most effective for the HF low bands.
	P.AMP 2	High-gain preamplifier. It is most effective for the higher bands.
144 MHz 430 MHz	P.AMP	Amplifies received signals.

**NOTE:** When you use the preamp while receiving strong signals, the receiving signal may be distorted. In such case, turn OFF the preamp.

## Attenuator

### Except for 144 and 430 bands

The Attenuator prevents a desired signal from becoming distorted when a very strong signal is near the frequency, or when a very strong electric field, such as from a broadcasting station, is near your location.

① Each band memorizes the Attenuator setting.

1. Push **[FUNCTION]**.
  - Opens the FUNCTION screen.
2. Touch **[P.AMP/ATT]** for 1 second.
  - ① Touching **[P.AMP/ATT]** again turns OFF the Attenuator.



3. To close the FUNCTION screen, push **[EXIT]**.

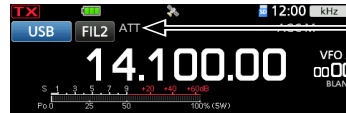

Displayed when the Attenuator is ON.

① If a strong signal is received and "OVF" (Overflow) is displayed, turn ON the attenuator, or reduce the RF gain until "OVF" disappears. (p. 3-8)

## RIT function

The Receive Increment Tuning (RIT) function compensates for differences in frequencies of other stations.

The function shifts your receive frequency up to  $\pm 9.99$  kHz without shifting the transmit frequency.

1. Push **[RIT/ΔTX]**.

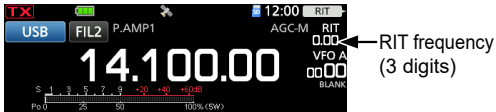

- The RIT function turns ON.
- ① If the  $\Delta TX$  function turns ON, hold down **[RIT/ΔTX]** for 1 second.
  - ① While using the Fine Tuning function (p. 3-3), the RIT frequency is displayed in 4 digits, instead of 3.
  - ① Pushing **[RIT/ΔTX]** again turns OFF the RIT function.
2. Rotate **[MULTI]** to set the RIT frequency to match the received station's frequency.



- ① You can reset the RIT frequency to "0.00" by holding down **[MULTI]** for 1 second.
3. After communicating, push **[RIT/ΔTX]** to turn the RIT function OFF.

### ◇ RIT monitor function

When the RIT function is ON, you can directly monitor the operating frequency by holding down **[XFC]**.

- ① While monitoring, the RIT function is temporarily OFF.
- ① While monitoring, the settings for the Noise Reduction, Notch filter, and Twin PBT are temporarily OFF.

## Monitor function

The Monitor function enables you to monitor your transmit audio. Use this function to check the voice characteristics while adjusting transmit audio parameters.

- ① You can hear the CW sidetone regardless of the Monitor function setting.

1. Select the operating mode that you want to monitor. (Example: USB)
2. Push **[FUNCTION]**.
  - Opens the FUNCTION screen.
3. Touch **[MONI]** to turn ON the Monitor function.
  - ① Touching **[MONI]** turns the Monitor function ON or OFF.



4. If you want to adjust the monitor audio output, touch **[MONI]** for 1 second.
5. Rotate **[MULTI]** to adjust MONITOR to the clearest audio output between 0% and 100%, while speaking at your normal voice level.



6. To close the Multi-function menu, push **[MULTI]**.

**NOTE:** When using the VOX function, turn OFF the Monitor function. Otherwise, the transmitted audio will echo.

## AGC function control

### SSB, CW, RTTY, and AM modes

The Automatic Gain Control (AGC) function controls receiver gain to produce a constant audio output level, even when the received signal strength greatly varies.

① Each mode and band memorizes the AGC setting.

### ◇ Selecting the AGC time constant preset value

The transceiver has FAST, MID, and SLOW preset AGC settings for all modes, except for the FM, WFM, and DV modes.

1. Select the operating mode. (Example: SSB)
2. Push **[FUNCTION]**.
  - Opens the FUNCTION screen.
3. Touch **[AGC]** to select the desired time constant.
  - ① Touching **[AGC]** selects FAST, MID, or SLOW.
  - ① For FM, WFM, and DV modes, FAST is fixed.



4. To close the FUNCTION screen, push **[EXIT]**.

**NOTE:** While you are receiving weak signals, and a strong signal is momentarily received, the AGC function quickly reduces the receiver gain. When that signal disappears, the transceiver may not receive the weak signal because of the AGC action. In that case, select FAST, or touch **[AGC]** for 1 second to open the AGC screen, and then select OFF.

### ◇ Setting the AGC time constant

You can set the preset AGC time constant to the desired value.

1. Select the operating mode. (Example: SSB)
2. Push **[FUNCTION]**.
  - Opens the FUNCTION screen.
3. Touch **[AGC]** for 1 second.

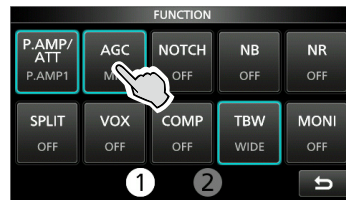

- Opens the AGC (SSB) screen.
4. Touch FAST, MID, or SLOW. (Example: MID)

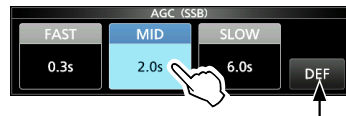

You can reset to the default settings by touching this key for 1 second.

5. Rotate **[MAIN DIAL]** to set the time constant.
6. To close the AGC (SSB) screen, push **[EXIT]**.

### Selectable AGC Time constant (unit: seconds)

Mode	Default	Adjustable time constant
LSB USB	0.3 (FAST)	OFF, 0.1, 0.2, 0.3, 0.5, 0.8,
	2.0 (MID)	1.2, 1.6, 2.0, 2.5, 3.0, 4.0,
	6.0 (SLOW)	5.0, or 6.0
CW/RTTY	0.1 (FAST)	OFF, 0.1, 0.2, 0.3, 0.5, 0.8,
	0.5 (MID)	1.2, 1.6, 2.0, 2.5, 3.0, 4.0,
	1.2 (SLOW)	5.0, or 6.0
AM	3.0 (FAST)	OFF, 0.3, 0.5, 0.8, 1.2, 1.6,
	5.0 (MID)	2.0, 2.5, 3.0, 4.0, 5.0, 6.0,
	7.0 (SLOW)	7.0, or 8.0
FM/WFM/DV	0.1 (FAST)	Fixed

## Using the Digital Twin PBT

### SSB, CW, RTTY, and AM modes

To reject interference, the Digital Twin Passband Tuning (PBT) narrows the IF passband width by electronically shifting the IF frequency to slightly above or below the IF center frequency. The IC-705 uses the digital function using the FPGA (Field Programmable Gate Array) filtering method.

① Each mode memorizes the PBT setting.

1. Push **(TWIN PBT)** to select “PBT1.”  
① Each push selects “PBT1” or “PBT2.”



2. Rotate **(TWIN PBT)** to adjust the shift value.
  - The passband width and shift value are displayed.
  - ① Hold down **(TWIN PBT)** for 1 second to clear the PBT setting.
3. Repeat steps 1 and 2 to adjust the shift value for “PBT2.”

### ① Information

- To narrow the IF passband width, shift “PBT1” and “PBT2” to the opposite direction from each other, to narrow the overlapped area.
- To shift the IF left or right, set “PBT1” and “PBT2” to the same value.
- The PBT is adjustable in 50 Hz steps in the SSB, CW, and RTTY modes, and 200 Hz in the AM mode. In this case, the center shift value changes in 25 Hz steps in the SSB, CW, and RTTY modes, and 100 Hz in the AM mode.

**NOTE:** While rotating **(TWIN PBT)**, you may hear some noise. This comes from the FPGA and does not indicate an equipment malfunction.

### ① Information

- A dot “.” is displayed on the IF Filter Indicator when you change the IF passband width, using the Digital Twin PBT.

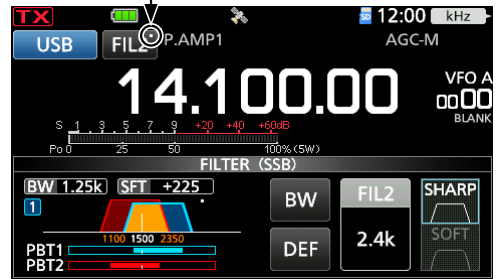

- Touch the filter icon for 1 second to display the current passband width and shift value. Opens the FILTER screen.

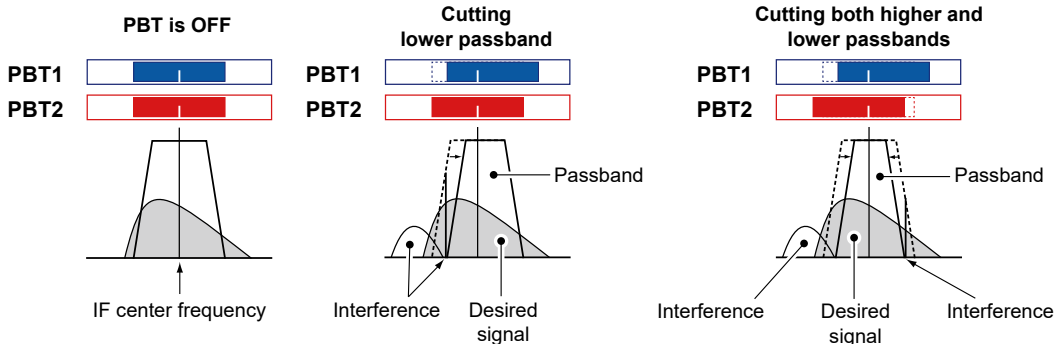
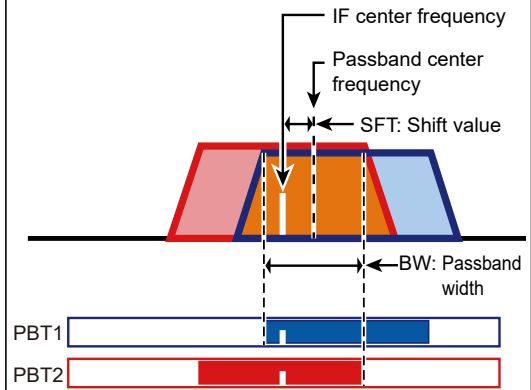
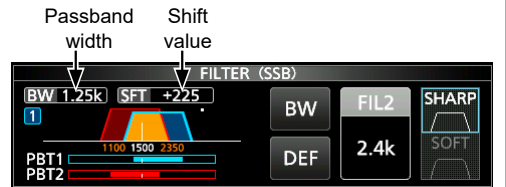

## Selecting the IF filter

### SSB, CW, RTTY, and AM modes

The IC-705 has 3 IF filter passband widths for each mode, and you can select them on the FILTER screen.

You can set the IF filter to wide (FIL 1), mid (FIL 2), or narrow (FIL 3).

1. Select the operating mode. (Example: USB)
2. Touch the filter icon for 1 second.

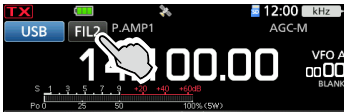

- Opens the FILTER (SSB) screen.

3. Touch the filter icon several times to select FIL 1 (wide), FIL 2 (mid), or FIL 3 (narrow).
4. Touch [BW].



You can reset to the default settings by touching this key for 1 second.

- Selects the passband width mode.

5. Rotate **(MAIN DIAL)** to select the passband width.
  - ① You cannot change the passband width in the FM, FM-D, WFM, or DV mode.
  - ① When you change the passband width, the Digital Twin PBT setting value is reset to the center position.
  - ① "BPF" is displayed when a band width less than 500 Hz is selected in the SSB, CW, or RTTY mode.
6. To close the FILTER screen, push **(EXIT)**.

**TIP:** When you set the IF filter to FIL2 or FIL3 in the FM mode, the transceiver will transmit in the FM narrow mode.

Mode	IF filter	Selectable range (steps)
SSB	FIL 1 (3.0 kHz)	50 Hz to 500 Hz (50 Hz)/ 600 Hz to 3.6 kHz (100 Hz)
	FIL 2 (2.4 kHz)	
	FIL 3 (1.8 kHz)	
SSB-D	FIL 1 (3.0 kHz)	50 Hz to 500 Hz (50 Hz)/ 600 Hz to 3.6 kHz (100 Hz)
	FIL 2 (1.2 kHz)	
	FIL 3 (500 Hz)	
CW	FIL 1 (1.2 kHz)	50 Hz to 500 Hz (50 Hz)/ 600 Hz to 3.6 kHz (100 Hz)
	FIL 2 (500 Hz)	
	FIL 3 (250 Hz)	
RTTY	FIL 1 (2.4 kHz)	50 Hz to 500 Hz (50 Hz) 600 Hz to 2.7 kHz (100 Hz)
	FIL 2 (500 Hz)	
	FIL 3 (250 Hz)	
AM AM-D	FIL 1 (9.0 kHz)	200 Hz to 10.0 kHz (200 Hz)
	FIL 2 (6.0 kHz)	
	FIL 3 (3.0 kHz)	
FM FM-D DV	FIL 1 (15 kHz)	Fixed
	FIL 2 (10 kHz)	
	FIL 3 (7.0 kHz)	
WFM	FIL 1 (200 kHz)	Fixed

## Selecting the IF filter shape

### SSB and CW modes

You can set the IF filter shape for each mode.

1. Select the operating mode. (Example: USB)
2. Touch the filter icon for 1 second.
  - Opens the FILTER (SSB) screen.
3. Touch [SHARP] or [SOFT].

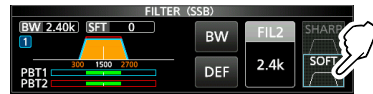

4. To close the FILTER screen, push **(EXIT)**.

#### • SHARP

This selection is to emphasize the passband width of the filter. The filter has an almost ideal shape factor. Signals that are out of the passband are extremely filtered out, and it gives you better audio quality.

#### • SOFT

The filter shoulders are roundly formed as in analog filters. This decreases noise components in the high and low frequencies of the filter passband, and increases the S/N of the target signal. These characteristics play an effective role in picking up very weak signals in the 50 MHz band, for example. The shape factor is retained, and the sharpness of the bandpass is excellent.

## Notch Filter

### SSB, CW, RTTY, AM, and FM modes

The IC-705 has Auto Notch and Manual Notch functions.

Auto Notch automatically attenuates beat tones, tuning signals, and so on. It can be used in the SSB, AM, and FM modes.

Manual Notch attenuates beat tones, tuning signals, and so on by manually adjusting the filtering frequency. It can be used in the SSB, CW, RTTY, and AM modes.

### ◇ Selecting the Notch filter type

1. Push **[FUNCTION]**.
  - Opens the FUNCTION screen.
2. Touch **[NOTCH]**.
  - ① Touching **[NOTCH]** changes between “AN (Auto Notch),” “MN (Manual Notch),” and OFF.



3. To close the FUNCTION screen, push **[EXIT]**.

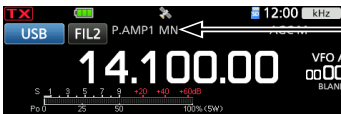

Displayed when a notch filter is selected.

### ◇ Setting the Manual Notch filter

When Manual Notch is selected, adjust the filtered frequency.

1. Push **[FUNCTION]**.
  - Opens the FUNCTION screen.
2. Touch **[NOTCH]** for 1 second.



- Opens the NOTCH menu.
  - The Manual Notch is automatically selected, and “MN” is displayed.
3. Touch **[WIDTH]** several times to select the Manual Notch filter width from “WIDE,” “MID,” and “NAR.”

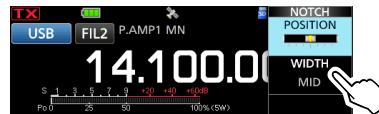

4. Rotate **[MULTI]** slowly, to manually attenuate the frequency.
5. To close the NOTCH menu, push **[EXIT]**.

**NOTE:** While adjusting, noise may be heard. This comes from the FPGA and does not indicate an equipment malfunction.

## Noise Blanker

### SSB, CW, RTTY, and AM modes

The Noise blanker eliminates pulse-type noise, such as the noise from car ignitions.

1. Push **[FUNCTION]**.
  - Opens the FUNCTION screen.
2. Touch **[NB]**.
  - ① Touching **[NB]** turns this function ON or OFF.

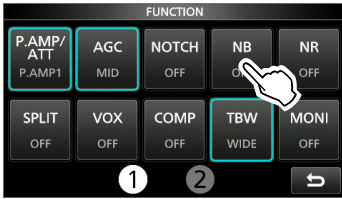

3. To close the FUNCTION screen, push **[EXIT]**.

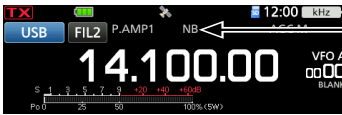

Displayed when the Noise Blanker is ON.

**NOTE:** When using the Noise Blanker, received signals may be distorted if they are excessively strong, or the noise is other than a pulse type. In that case, turn OFF the Noise Blanker, or shallow the DEPTH on the NB menu. See the description below for details.

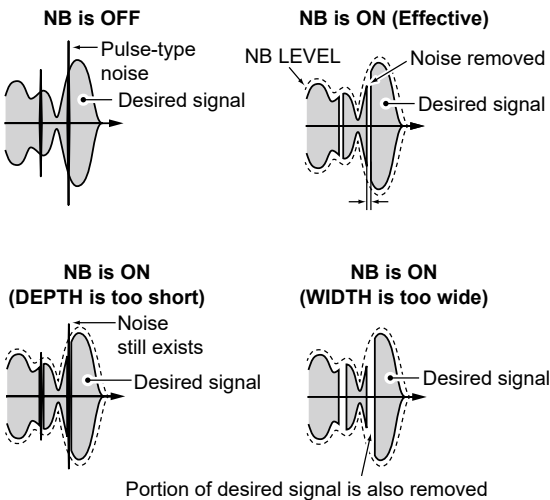

### ◇ Adjusting the NB level and time

To deal with various type of noise, you can adjust the attenuation level and blanking depth and width in the NB menu.

1. Push **[FUNCTION]**.
  - Opens the FUNCTION screen.
2. Touch **[NB]** for 1 second.

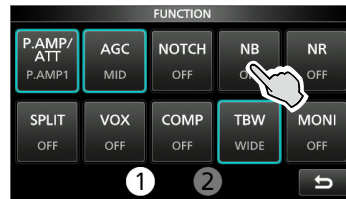

- Turns ON the Noise Blanker and opens the NB menu.

3. Touch the item to adjust. (Example: DEPTH)

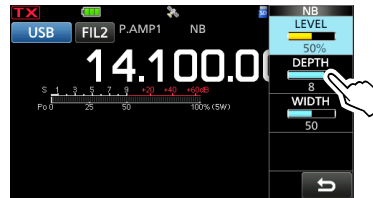

4. Rotate **[MULTI]** to adjust the item. (Example: 8)
5. To close the NB menu, push **[MULTI]**.

**LEVEL** \_\_\_\_\_ (Default: 50%)

Adjusts the level where the Noise Blanker activates between 0 and 100%.

**DEPTH** \_\_\_\_\_ (Default: 8)

Adjusts the noise attenuation level to between 1 and 10.

**WIDTH** \_\_\_\_\_ (Default: 50)

Adjusts the blanking duration time to between 1 and 100.



## Noise Reduction

The Noise Reduction function reduces random noise components and enhances signal audio.

1. Push **[FUNCTION]**.
  - Opens the FUNCTION screen.
2. Touch **[NR]**.
  - ① Touching **[NR]** turns this function ON or OFF.



3. To close the FUNCTION screen, push **[EXIT]**.

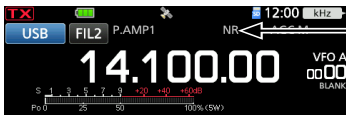

Displayed when the Noise Reduction function is ON.

### ◇ Adjusting the Noise Reduction level

Adjust the Noise Reduction level to where noise is reduced but the received signal is not distorted.

1. Push **[FUNCTION]**.
  - Opens the FUNCTION screen.
2. Touch **[NR]** for 1 second.
  - Turns ON the Noise Reduction function and opens the NR menu.
3. Rotate **[MULTI]** to adjust the Noise Reduction level to between 0 and 15.

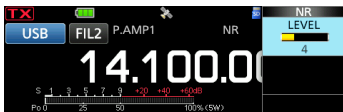

① Adjust to a higher level to increase the reduction level, and a lower level to decrease it.

4. To close the NR menu, push **[EXIT]**.

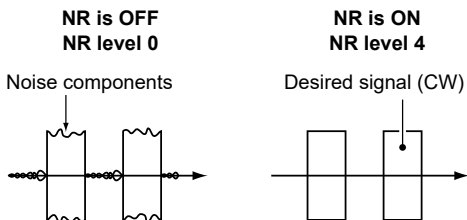

## Setting the transmit filter width

### SSB mode

The transmit filter width for the SSB and SSB-D modes can be set. WIDE (wide), MID (middle), or NAR (narrow) can be selected only in the SSB mode.

① The filter can be independently set on the speech compressor function is ON or OFF.

### To change the filter width in the SSB mode:

1. Set the operating mode to USB or LSB.
2. Push **[FUNCTION]**.
  - Opens the FUNCTION screen.
3. Touch **[TBW]**.
  - ① Touching **[TBW]** sets the filter width to WIDE, MID, or NAR.

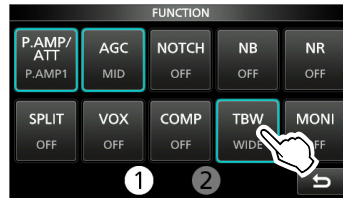

The transmit filter widths are set to the following values by default.

- SSB (WIDE): 100 Hz to 2900 Hz
- SSB (MID): 300 Hz to 2700 Hz
- SSB (NAR): 500 Hz to 2500 Hz
- SSB-D: 300 Hz to 2700 Hz

① You can change the filter width values in the following settings.

**[MENU]** » SET > Tone Control/TBW > TX > SSB > **TBW (WIDE)**

**[MENU]** » SET > Tone Control/TBW > TX > SSB > **TBW (MID)**

**[MENU]** » SET > Tone Control/TBW > TX > SSB > **TBW (NAR)**

**[MENU]** » SET > Tone Control/TBW > TX > SSB-D > **TBW**

## Setting the Speech Compressor

### SSB mode

The Speech Compressor increases the average RF output power, improving readability at the receiving station. This function compresses the transmitter audio input to increase the average audio output level.

① The function is effective for long-distance communication, or when propagation conditions are poor.

### ◇ Setting before using the Speech Compressor function

1. Select the SSB mode. (Example: USB)
2. Push **[FUNCTION]**.
  - Opens the FUNCTION screen.
3. Be sure the Speech Compressor is OFF.
  - ① If it is ON, touch [COMP] to turn it OFF.

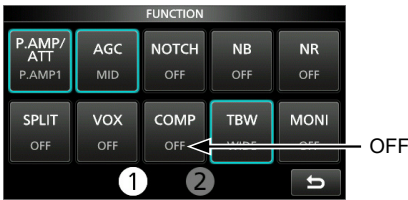

4. Push **[EXIT]** to close the FUNCTION screen.
5. Touch the Multi-function meter until the ALC meter is displayed.
  - ① Touching the Multi-function meter sets the meter to Po, SWR, ALC, COMP, Vd, or Id.

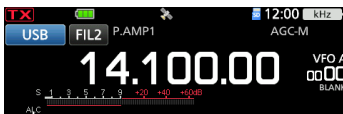

ALC meter

6. Push **[MULTI]** to open the Multi-function menu.
7. Touch **[MIC GAIN]**, and then rotate **[MULTI]** to adjust it by speaking into the microphone to where the ALC meter reads within the 30 to 50% range of the ALC zone.

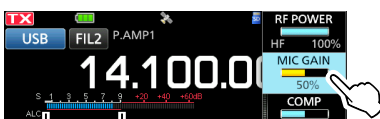

ALC zone

### ◇ Using the Speech Compressor function

1. Touch the Multi-function meter again to display the COMP meter.
2. Push **[FUNCTION]**.
  - Opens the FUNCTION screen.
3. Touch **[COMP]** for 1 second.



• Turns ON the Speech Compressor function and opens the Multi-function menu.

4. While speaking into the microphone at your normal voice level, rotate **[MULTI]** to adjust the Speech Compressor level to where the COMP meter reads within the COMP zone (10 to 20 dB range).
  - ① If the COMP meter peaks exceed the COMP zone, your transmitted voice may be distorted.

Speech Compressor is ON

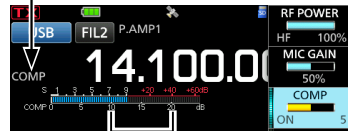

COMP zone

5. To close the Multi-function menu, push **[MULTI]**.

## Split frequency operation

Split frequency operation enables you to transmit and receive on different frequencies in the same band.

There are 2 ways to use Split frequency operation.

- Use the Quick Split function
- Use the receive and transmit frequencies set to VFO A and VFO B.

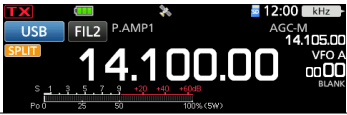
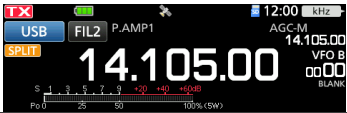
The other station		Your station	
Transmit frequency	USB mode 14.100 MHz	VFO A Receive frequency	
Receive frequency	USB mode 14.105 MHz	VFO B Transmit frequency	

4

### ◇ Using the Quick Split function

The Quick Split function enables you to automatically equalize the frequency and mode of the VFOs to the displayed VFO, and activate the Split function.

1. Set VFO A's receive frequency and operating mode.  
(Example: 14.100 MHz in the USB mode)
2. Push **[FUNCTION]**.
  - Opens the FUNCTION screen.
3. Touch **[SPLIT]** for 1 second.
4. While holding down **[XFC]**, set the operating frequency offset between transmit and receive. (Example: 5.00 kHz)

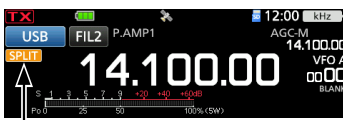

← VFO B frequency is displayed.

Displayed

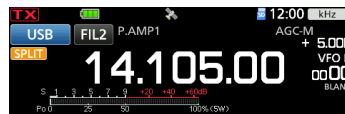

← The offset between transmit and receive while holding down **[XFC]**.

- The Quick Split function is turned ON, and the VFO A settings are set to VFO B.

## Split frequency operation

### ◇ Using the receive and transmit frequencies set to VFO A and VFO B

1. Set VFO A's receive frequency and operating mode.  
(Example: 14.100 MHz in the USB mode)

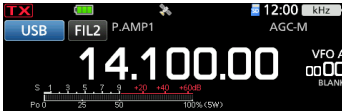

2. Select VFO B, and then set the receive frequency and the operating mode.  
(Example: 14.105 MHz in the USB mode)

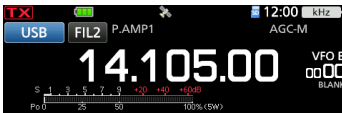

3. Push **[FUNCTION]**.
  - Opens the FUNCTION screen.
4. Touch **[SPLIT]** to turn ON the Split function.
  - ① Touching **[SPLIT]** turns the Split function ON or OFF.



5. To close the FUNCTION screen, push **[EXIT]**.

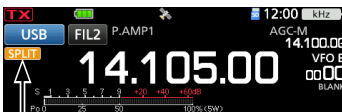

VFO A frequency is displayed.

Displayed

6. Return to VFO A.



VFO B frequency is displayed.

- ① The Split frequency operation is ready.

## Split Lock function

To prevent accidentally changing the receive frequency by releasing **[XFC]** while rotating **(MAIN DIAL)**, use the Split Lock function. Using both this function and the Dial Lock function enables you to change only the transmit frequency.

1. Turn ON the Split Lock function.
  - [MENU]** » **SET > Function > SPLIT > SPLIT LOCK**
2. Turn ON the Split function.
3. Hold down **[SPEECH]** for 1 second to turn ON the Dial Lock function.
4. While holding down **[XFC]**, set the transmit frequency.

## Operating CW

### ◇ Setting the CW pitch control

You can set the received CW audio pitch and the CW side tone to suit your preference, without changing the operating frequency.

1. Select the CW mode.
2. Push **[MULTI]** to open the Multi-function menu.
3. Touch **[CW PITCH]**.

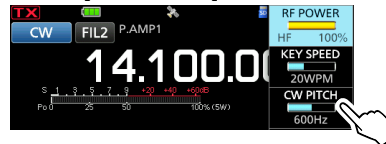

4. Rotate **[MULTI]** to set the CW pitch to between 300 and 900 Hz (in 5 Hz steps).
5. To close the Multi-function menu, push **[MULTI]**.

### ◇ Setting the key speed

You can set the keying speed of the internal electronic keyer.

1. Select the CW mode.
2. Push **[MULTI]** to open the Multi-function menu.
3. Touch **[KEY SPEED]**.

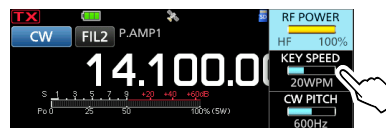

4. Rotate **[MULTI]** to set the key speed to between 6 and 48 Words Per Minute (WPM).
5. To close the Multi-function menu, push **[MULTI]**.

## Operating CW

## ◇ Using the Break-in function

Use the Break-in function in the CW mode to automatically switch between transmit and receive when keying. The IC-705 is capable of operating in the Semi Break-in and Full break-in modes.

**TIP:** “Key Type” is set to “Paddle” by default. You can select the keyer type in the following item.

**[MENU]** » **KEYER > EDIT/SET > CW-KEY SET > Key Type**

## Semi Break-in operation

In the Semi Break-in mode, the transceiver transmits when keying, and then automatically returns to receive after a preset time after you stop keying.

1. Select the CW mode.
2. Push **[BK-IN]** several times to select “BKIN.”  
① Pushing **[BK-IN]** selects “BKIN (Semi Break-in),” “F-BKIN (Full Break-in),” or OFF (no indication).

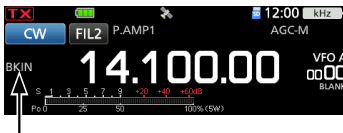

The selected mode (Semi Break-in) is displayed.

3. To adjust the Break-in delay time, hold down **[BK-IN]** for 1 second.
  - Opens the BKIN menu.
4. Rotate **[MULTI]** to set to where the transceiver returns to receive after the desired delay time after you stop keying.

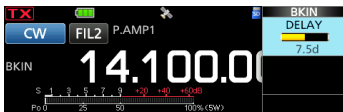

① When you are using a paddle, push **[MULTI]** to open the Multi-function menu, and then adjust the KEY SPEED (p. 4-11) while operating the paddle.

5. To close the BKIN menu, push **[EXIT]**.

## Full Break-in operation

In the Full Break-in mode, the transceiver automatically transmits while keying down, and then immediately returns to receive after keying up.

1. Select the CW mode.
2. Push **[BK-IN]** several times to display “F-BKIN.”  
① Pushing **[BK-IN]** selects “BKIN (Semi Break-in),” “F-BKIN (Full Break-in),” or OFF (no indication).

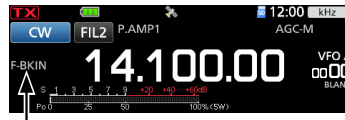

The selected mode (Full Break-in) is displayed.

3. Use a straight key or paddle.  
① In the Full break-in mode, the transceiver automatically returns to receive immediately after you key up. The transceiver receives while keying up.

## ◇ Monitoring the CW side tone

When the transceiver is in standby and the Break-In function is OFF, you can listen to the CW side tone without actually transmitting.

## ① Information

- This enables you to match your transmit frequency exactly to another station's by matching the audio tone.
- You can also use the CW side tone (make sure the Break-in function is OFF) to practice CW sending.
- You can adjust the CW side tone level in the following item.

**[MENU]** » **KEYER > EDIT/SET > CW-KEY SET > Side Tone Level**

## Operating CW

### ◇ About the electronic Keyer function

You can set the Memory Keyer function settings, paddle polarity settings, and so on of the Electronic Keyer.

1. Select the CW mode.
2. Open the KEYSER screen.

[MENU] » [KEYER]

3. Touch [EDIT/SET].



- Opens the EDIT/SET screen.

4. Select the desired item to set.

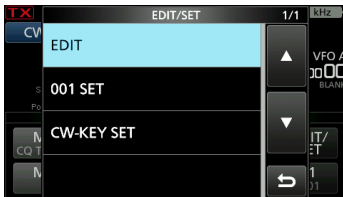

5. To close the KEYSER screen, push [EXIT] several times.

EDIT

**KEYER MEMORY edit menu**  
You can edit the Keyer memories M1 to M8.

001 SET

**KEYER 001 Contest Number menu**  
You can set the following items.

- Number Style
- Count Up Trigger
- Present Number

CW-KEY SET

**CW-KEY SET menu**  
You can set the following items.

- Side Tone Level
- Side Tone Level Limit
- Keyer Repeat Time
- Dot/Dash Ratio
- Rise Time
- Paddle Polarity
- Key Type
- MIC Up/Down Keyer

## Auto Tuning function

### CW mode

You can tune in a CW signal you are receiving using the Auto Tuning function. You can automatically tune by pushing [AUTOTUNE (RX-CS)]. This function is active only in the CW mode.

- ① While using the RIT function, the RIT frequency is automatically tuned by this function.

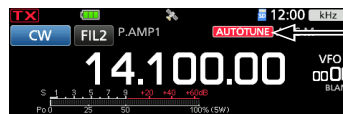

Displayed while tuning

**NOTE:** When receiving a weak signal, or receiving a signal with interference, the Auto Tuning function may tune the receiver to an undesired signal, or may not start to tune. In such case, a warning beep sounds.

- ① The Auto Tuning function tunes the frequency in the IF bandwidth.

**Spectrum scope screen**

The spectrum scope enables you to display the activity on the selected band, as well as the relative strengths of various signals in that band.

The transceiver has two spectrum scope modes, the Center mode and the Fixed mode. You can also turn the Waterfall display ON or OFF. In addition, you can select the Mini scope to display the scope in a smaller size on the screen.

**Center mode screen**

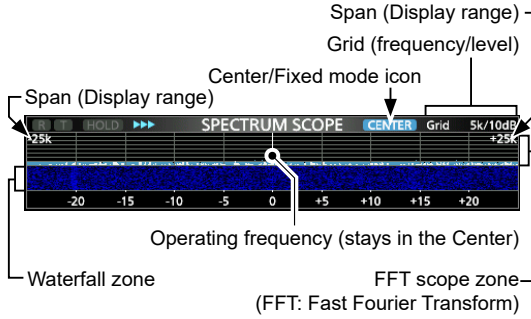

**Fixed mode screen**

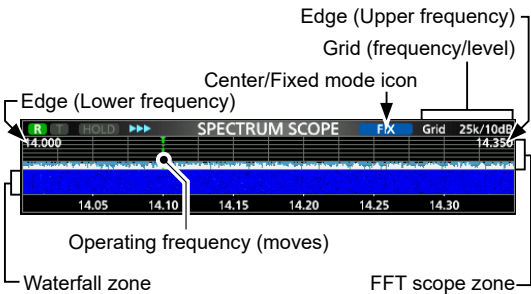

**Marker**

The Marker displays the operating frequency in the SPECTRUM SCOPE screen.

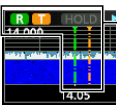

- R:** The RX marker
  - Marks the receive frequency.
- T:** The TX marker
  - Marks the transmit frequency.

**About RX Marker**

In the Fixed mode, the RX Marker displays the operating frequency within a specified frequency range. So, the transceiver always displays the RX marker in the Scope screen.

In the Center mode, the operating frequency stays in the center of the screen. Thus, the transceiver does not display the RX Marker.

① When the Hold function is ON, the RX Marker is displayed to indicate the operating frequency's location.

**Using the Spectrum Scope**

Display the SPECTRUM SCOPE screen.

**(MENU) » SCOPE**

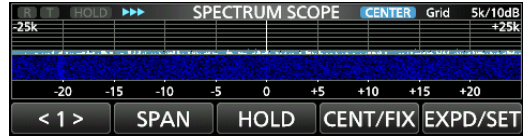

MENU 1: Center mode



MENU 1: Fix mode



MENU 2: Center/Fix mode

Key	Action	
< 1 > < 2 >	Selects the Function menus.	
SPAN	Touch	In the Center mode, selects the scope span. • ± 2.5, 5.0, 10, 25, 50, 100, 250, or 500 kHz
	Touch for 1 second	Resets to the ±2.5 kHz span.
EDGE	In the Fixed mode, selects the Edge frequencies. ① You can set the upper and lower Edge frequencies in "Fixed Edges" on the SCOPE SET screen by touching [EXPD/SET] for 1 second.	
HOLD	Touch	Turns the Hold function ON or OFF. • <b>(HOLD)</b> and the Marker are displayed. Freezes the current spectrum.
	Touch for 1 second	Clears the Peak Hold level.
CENT/FIX	Selects the Center or Fixed mode.	
EXPD/SET	Touch	Selects the Expanded or Normal screen.
	Touch for 1 second	Displays the SCOPE SET screen.
REF	Opens the "REF Level" window. ① Rotate <b>(MAIN DIAL)</b> to adjust the Reference level. ① Touch again to close the window.	
SPEED	Selects the sweep speed. • "▶▶▶" (FAST), "▶▶" (MID), or "▶" (SLOW).	
MARKER	Selects the Marker.	

## Spectrum scope screen

### ◇ Center mode

Displays signals around the operating frequency within the selected span. The operating frequency is always displayed in the center of the screen.

1. Display the SPECTRUM SCOPE screen.  
**[MENU]** » **[SCOPE]**
2. Touch [CENT/FIX] to select the Center mode.  
 ① Touch [CENT/FIX] to toggle between the Center and Fixed modes.
3. Touch [SPAN] several times to select the scope span.  
 • ±2.5, 5.0, 10, 25, 50, 100, 250, and 500 kHz  
 ① Touch [SPAN] for 1 second to select the ±2.5 kHz span.

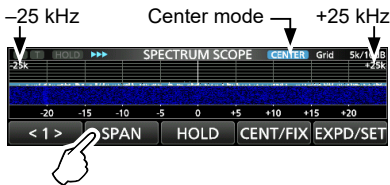

### ◇ Fixed mode

Displays signals within a specified frequency range. The selected frequency band activity can easily be observed in this mode.

Three Fixed Edge bands can be set for each amateur frequency band covered by the transceiver in the SCOPE SET screen.

1. Display the SPECTRUM SCOPE screen.  
**[MENU]** » **[SCOPE]**
2. Touch [CENT/FIX] to select the Fixed mode.  
 ① Touch [CENT/FIX] to toggle between the Center and Fixed modes.
3. Touch [EDGE] several times to select the Edge frequency.  
 ① When the operating frequency moves outside the upper or lower Edge frequency, "<<" or ">>" is displayed in the upper side corners of the SPECTRUM SCOPE screen.  
 <<: The frequency is outside the lower edge.  
 >>: The frequency is outside the higher edge.  
 When the frequency goes further away, "Scope Out of Range" is displayed.

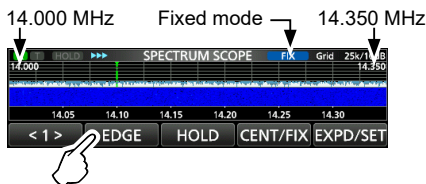

### ◇ Touch screen operation

By touching the FFT scope zone or the waterfall zone in the SPECTRUM SCOPE screen, the area will be zoomed in. Then you touch the signal in the zoomed area, you can directly tune your frequency to the signal.

① Holding down **[XFC]** changes the transmit frequency.

1. Display the SPECTRUM SCOPE screen.  
**[MENU]** » **[SCOPE]**
2. Touch the Scope screen.

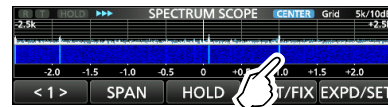

- The area around the touched point is zoomed in.
3. Touch the signal in the zoomed area.

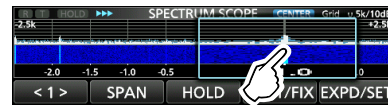

### ① Information

- In the Center mode, the operating frequency changes to the touched point, and the point moves to the screen center.
- In the Fixed mode, the operating frequency and marker change to the touched point.
- Touch out of the zoomed area to close the zoomed window.

### ◇ Mini scope screen

The Mini scope screen can be simultaneously displayed with another function displays, such as the RTTY DECODE screen and the AUDIO SCOPE screen.

Push **[M.SCOPE]** to turn the Mini scope screen ON or OFF.

① Hold down **[M.SCOPE]** for 1 second to display the SPECTRUM SCOPE screen.

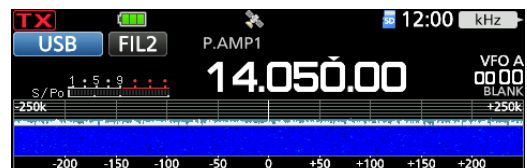



## Audio scope screen

This audio scope enables you to display the received signal's frequency component on the FFT scope, and its waveform components on the Oscilloscope. The FFT scope also has a waterfall.

Display the AUDIO SCOPE screen.

**MENU** » **AUDIO**

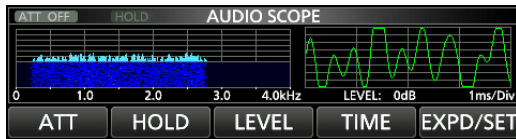

Key	Action	
ATT	Touch	Selects the attenuator for the FFT scope. • 0 (OFF), 10, 20, or 30 dB
	Touch for 1 second	Turns OFF the attenuator. (0 dB)
HOLD	Turns the Hold function ON or OFF. • [HOLD] is displayed and freezes the current audio spectrum.	
LEVEL	Selects the Oscilloscope level. • 0, -10, -20, or -30 dB	
TIME	Selects the Oscilloscope sweep time. • 1, 3, 10, 30, 100, or 300 ms/Div	
EXPD/SET	Touch	Selects the Expanded or Normal screen.
	Touch for 1 second	Displays the AUDIO SCOPE SET screen.

### • AUDIO SCOPE screen

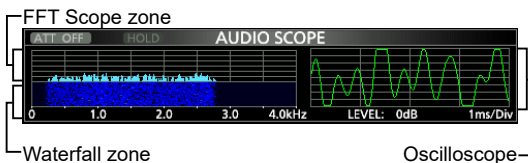

### ◇ AUDIO SCOPE SET screen

This screen is used to set the FFT scope waveform type, color, Waterfall display, and oscilloscope waveform color.

1. Display the AUDIO SCOPE screen.

**MENU** » **AUDIO**

2. Touch [EXPD/SET] for 1 second.
3. Touch the item to set.  
(Example: FFT Scope Waveform Type)



4. Touch the option to set.  
① See below for details on the setting items and their options.
5. To close the AUDIO SCOPE SET screen, push **EXIT**.

**TIP:** You can set each item to its default by touching the item for 1 second, and then touching "Default" on the QUICK MENU screen.

### FFT Scope Waveform Type (Default: Fill)

Selects the type of waveform for the FFT scope.

- Line: Only the waveform outline is drawn.
- Fill: The full waveform is drawn in color.

### FFT Scope Waveform Color

(Default: (R) 51 (G) 153 (B) 255)

Sets the waveform color for the FFT scope.

- ① Touch and select the R (Red), G (Green), or B (Blue) scale, and then rotate **⊕MULTI** to adjust the level from 0 to 255.

- ① The color is displayed in the box above the RGB scale.

### FFT Scope Waterfall Display (Default: ON)

Turns the Waterfall display ON or OFF.

- OFF: Turns OFF the Waterfall display.
- ON: Turns ON the Waterfall display.

### Oscilloscope Waveform Color

(Default: (R) 0 (G) 255 (B) 0)

Sets the waveform color for the Oscilloscope.

- ① Touch and select the R (Red), G (Green), or B (Blue) scale, and then rotate **⊕MULTI** to adjust the level from 0 to 255.

- ① The color is displayed in the box above the RGB scale.

# 6

## microSD CARD

The microSD cards and microSDHC cards are user supplied.

**TIP:** Icom recommends that you save the transceiver's factory default data for backup.

### About the microSD cards

You can use a microSD card of up to 2 GB, or a microSDHC of up to 32 GB. Icom has checked the compatibility of the following cards.

(As of October 2020)

Brand	Type	Memory size
SanDisk®	microSD	2 GB
	microSDHC	4/8/16/32 GB

- ① The above list does not guarantee the card's performance.
- ① Throughout the rest of this document, the microSD cards and microSDHC cards are simply called the microSD card or the card.

#### NOTE:

- Before using the microSD card, thoroughly read their instructions.
- If any of the following occur, the card's data may be corrupted or deleted.
  - You remove the card from the transceiver while it is still accessing the card.
  - A power failure occurs, or the power cable is disconnected, while accessing the card.
  - You drop, impact, or vibrate the card.
- Do not touch the contacts of the card.
- The transceiver may take a longer time to recognize a high capacity card.
- The card has a certain lifetime, so data reading or writing may not be possible after using it for a long period of time. In that case, use a new one. We recommend you to make a backup of the data onto another device.
- Icom will not be responsible for any damage caused by data corruption on a card.

### Saving data

You can save the following data onto the card.

- The transceiver's settings
- Communication/receive log and contents
- Automatic answering voice audio in the DV mode
- Voice audio for the Voice TX function
- RTTY decode log
- Captured screens
- Memory channel contents
- Your (UR) call sign memory
- Repeater List
- GPS memory
- Position data from the GPS receiver
- Pictures for the Share Pictures function
- Transmitted and received log of Share Picture
- Pictures for the Opening Picture setting

### Inserting

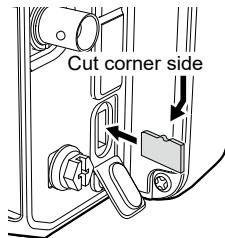

Insert the microSD card as shown to the left.

- ① Insert the microSD card into the slot until it locks in place, and makes a 'click' sound.
- ① Be sure to check the card orientation before inserting.

#### NOTE:

**Before using a microSD card for the first time, format it in the transceiver.**

- Formatting a card erases all its data. Before formatting any used card, back up its data onto another device.
- After inserting or formatting, a special folder on the card that you need for operations like updating the firmware is created on the card.

**IMPORTANT:** Even if you have formatted a microSD card, some data may remain in the card. When you dispose the card, be sure to physically destroy it to avoid unauthorized access to any data that remains.

### Formatting

Before using a microSD card, format it to be used with the transceiver by doing the following steps.

1. Open the SD CARD screen.

**MENU** » **SET > SD Card**

2. Touch "Format."

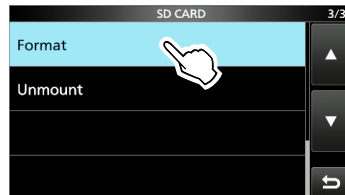

3. Touch [YES] to start formatting.

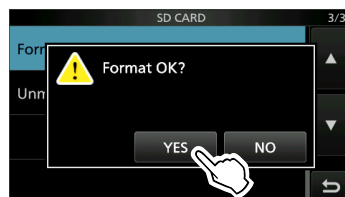

- After formatting, returns to the SD CARD screen.
- ① To cancel formatting, touch [NO].

4. To close the SD CARD screen, push **EXIT** several times.

## Saving the setting data

The Memory channels and the transceiver's settings can be saved onto a microSD card.

1. Open the SAVE SETTING screen.  
**[MENU]** » **SET > SD Card > Save Setting**
2. Touch "<<New File>>."



① The file name is automatically set in the following format: Setyyyyymmdd\_xx (yyyy: Year, mm: month, dd: day, xx: serial number).

3. To save the file with the displayed name, touch [ENT].

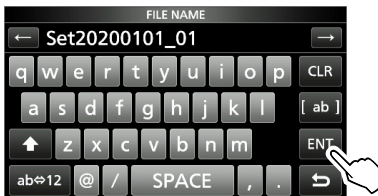

① If you want to change the name, delete the name and reenter it, and then touch [ENT].

4. Touch [YES].

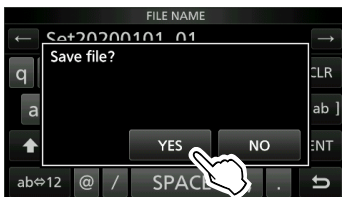

- Saves the data settings.

5. To close the SD CARD screen, push **[EXIT]** several times.

## Unmounting

Before you remove a card when the transceiver is ON, be sure to electrically unmount it, as shown below.  
 Otherwise, the data may be corrupted or deleted.

1. Open the SD CARD screen.  
**[MENU]** » **SET > SD Card**

2. Touch "Unmount."

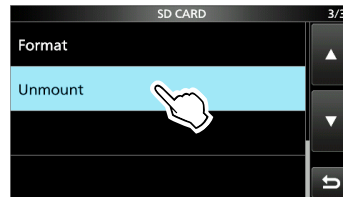

3. Touch [YES] to unmount.

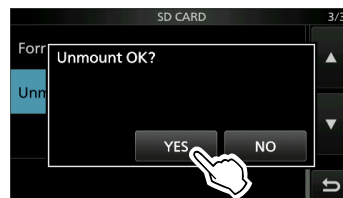

- After unmounting, returns to the SD CARD screen.

① To cancel unmounting, touch [NO].

4. Remove the card from the transceiver.

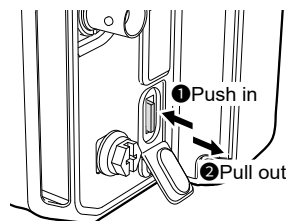

- Push in the card until a 'click' sounds to unlock the card, and then pull it out.

5. To close the SD CARD screen, push **[EXIT]** several times.

### When the transceiver is OFF

You can remove the card starting from step 4 of the steps described above.

**NOTE:** The built-in GPS receiver cannot calculate its position if it cannot receive signals from the GPS satellites. Refer to page xii for details.

## Confirming the GPS signal receiving

The transceiver has a built-in GPS receiver. You can check your current location, and transmit GPS data in the DV mode. See the Advanced Manual for details.

Confirm the GPS receiver is receiving satellite data.

The GPS icon blinks when searching for satellites.

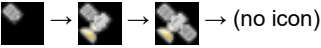

The GPS icon stops blinking when the minimum needed number of satellites are found.



① It may take only a few seconds to receive, or it may take a few minutes, depending on your operating environment. If you have difficulties receiving, we recommend that you try a different location.

① When “GPS Select” is set to “Manual,” the icon is not displayed.

**MENU** » **GPS > GPS Set > GPS Select**

**NOTE:** If you cannot receive GPS data, manually set the date and time. (p. 9-1)

**TIP: To prolong the battery life in the GPS mode**  
Manually update your location with the received GPS data.

1. Confirm the GPS receiver is receiving your location data.
2. Open the MANUAL POSITION screen.  
**MENU** » **GPS > GPS Set > Manual Position**
3. Push **QUICK**.
4. Touch “Capture From GPS.”
5. Set “GPS Select” to “Manual.”  
**MENU** » **GPS > GPS Set > GPS Select**

## Checking your location

You can check your current location.

① If you transmit while displaying the GPS POSITION screen, the screen closes.

1. Push **QUICK**.
2. Touch “GPS Position.”

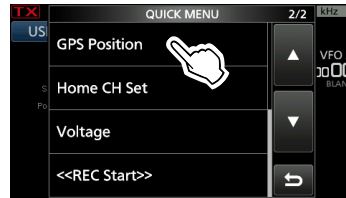

- Opens the GPS POSITION screen.
3. Rotate **MAIN DIAL**.
    - Changes between the MY (My position), RX (Received position), MEM (GPS Memory position), or ALM (GPS Alarm position) screen.
  4. To close the GPS POSITION screen, push **EXIT**.

## GPS POSITION (MY) screen

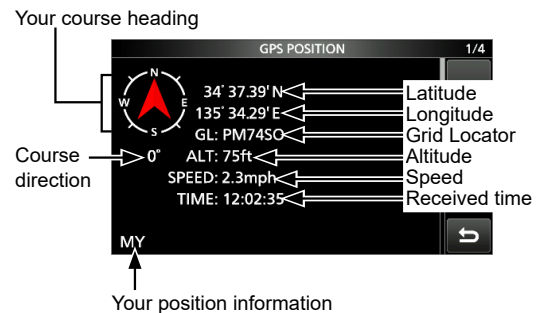

① When “GPS Select” is set to “Manual,” SPEED, Compass, and Compass Direction are not displayed.

## GPS Logger function

The GPS Logger function enables you to save the location data from a GPS receiver onto a microSD card as a log.

The GPS Logger saves Latitude, Longitude, Altitude, Positioning state, Course, Speed, Date, and Time.

If you use this GPS Logger while traveling, you can check your trip history on a mapping software.

### About the log file

If you have the log file imported to a mapping software, you can display your route as you move on the software map.

- ① The log files may not be compatible with all mapping software.
- ① See the Advanced Manual for details on copying the log files onto your PC.

### NOTE:

- The GPS logger function requires a microSD card (User supplied). (p. 6-1)
- This function is turned ON as the default setting. Therefore when you insert a microSD card, this function continuously saves the location data from the GPS receiver, even if you turn OFF the transceiver, then ON again.
- You can turn this function ON or OFF in the following item.  
**MENU** » **GPS > GPS Logger > GPS Logger**
- When the microSD card is full, this function will automatically be paused.

## Set mode description

You can use the Set mode to set infrequently changed values or function settings.

1. Push **[MENU]**.

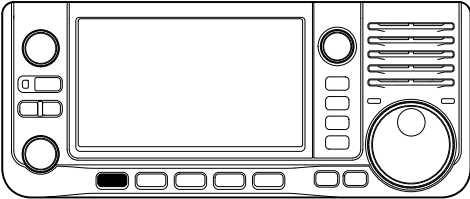

2. Touch **[SET]**.



3. Touch **[▲]** or **[▼]** to scroll through the items.
  - ① You can also rotate **[MULTI]** to scroll through the items.

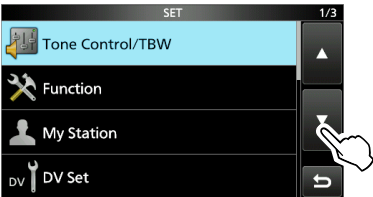

4. Touch the item to open the its setting screen, or to open its next tree level.

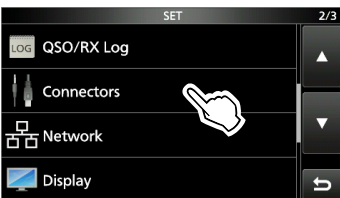

5. Repeat steps 3 and 4 to open the desired item's setting screen.
  - ① To go back a tree level, push **[EXIT]**.

**TIP:** The Set mode is constructed in a tree structure. You can go to the next tree level, or go back a level, depending on the selected item.

6. Touch to select or to set the option.

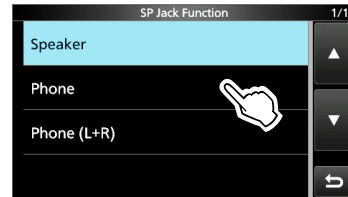

- The selected option is saved, and returns to the previous screen.

7. To close the SET screen, push **[EXIT]** several times.

### TIP: Resetting to the default setting

1. Push **[QUICK]** to display the QUICK MENU screen.
2. Touch "Default" to reset to the default setting.

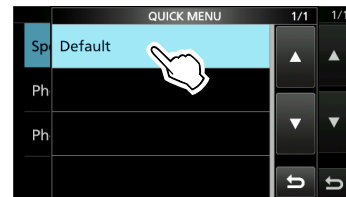

- ① To close the QUICK MENU screen, push **[EXIT]**.

**NOTE:** The default settings shown below are for the USA transceiver version. The default settings may differ, depending on your transceiver version.

## Tone Control/TBW

**MENU** » SET > Tone Control/TBW > **RX**

### SSB, AM, FM, DV, CW, RTTY

**RX HPF/LPF** (Default: - - - - -)

Sets the cut-off frequencies for the receive audio high-pass filter and low-pass filter, in 100 Hz steps.

① If this item is set, the “RX Bass” and “RX Treble” items are automatically set to “0.”

### SSB, AM, FM, DV, WFM

**RX Bass** (Default: 0)

**RX Treble** (Default: 0)

Sets the bass or treble level of the receive audio.

**MENU** » SET > Tone Control/TBW > **TX**

### SSB, AM, FM, DV

**TX Bass** (Default: 0)

**TX Treble** (Default: 0)

Sets the bass or treble level of the transmit audio.

### SSB

**TBW (WIDE)** (Default: 100 – 2900)

**TBW (MID)** (Default: 300 – 2700)

**TBW (NAR)** (Default: 500 – 2500)

Sets the transmission passband width to wide, mid, or narrow, by changing the lower and upper cut-off frequencies.

### SSB-D

**TBW (WIDE)** (Default: 300 – 2700)

Sets the transmission passband width by changing the lower and upper cut-off frequencies.

## Function

**MENU** » SET > **Function**

**Beep Level** (Default: 50%)

Sets the beep output level.

① If “Beep (Confirmation)” is set to “OFF,” no beeps sound.

**Beep Level Limit** (Default: ON)

Selects whether or not to limit the volume up to a specified level.

- OFF: Does not limit the volume level.
- ON: Limits the volume level.

**Beep (Confirmation)** (Default: ON)

Turns the Confirmation beep ON or OFF.

- OFF: Turns OFF the function for silent operation.
- ON: A beep sounds when a switch is pushed or the touch panel is touched.

① If “Beep Level” is set to “0%,” no beep sounds.

**Home CH Beep** (Default: ON)

Turns the Home CH Beep ON or OFF.

① In the VFO or Memory mode, when the Home Channel frequency or the Home Channel Memory is selected, the Home CH Beep sounds.

② In the DR screen, when the Home Channel Access repeater is set in FROM, the Home CH Beep sounds.

- OFF: No beep sounds.
- ON: Sounds a beep when you select the Home Channel.

**Band Edge Beep** (Default: ON (Default))

Selects an option for the Band Edge Beep function.

- OFF: Turns OFF the function.
- ON (Default): A beep sounds when you tune out of, or back into the default amateur band’s frequency range.
- ON (User): A beep sounds when you tune out of, or back into a user programmed amateur band’s frequency range.
- ON (User) & TX Limit:

A beep sounds when you tune out of, or back into a user programmed amateur band’s frequency range. Transmitting is inhibited outside of the range.

① If “Beep Level” is set to “0%,” no beep sounds.

**Auto Power OFF** (Default: OFF)

Selects whether or not to automatically turn OFF the transceiver after inactivity for this set period of time.

① “AUTO POWER OFF” is displayed and beeps sound 5 seconds before turning OFF the transceiver. If you operate the transceiver during this period of time, the Auto Power OFF timer is reset.

- OFF: Does not turn OFF the transceiver.
- 30/60/90/120min:

Turns OFF the transceiver after inactivity for this set period of time.

Function

MENU » SET > Function

Power Save

(Default: Auto (Short))

Sets the Power Save function to reduce the current drain and conserve battery power. When the Power Save function is activated, the call sign or the beginning of the signal may not be received correctly.

**NOTE:** The Power Save function is disabled when:

- Using an external power source.
- Scanning.
- Displays the SPECTRUM SCOPE screen.
- Displays the RTTY DECODE screen.
- Using the DV Gateway function.
- Using the VOX function.

- OFF: Turns OFF the function.
- Auto (Short): Sets the Power saving time to "Short."

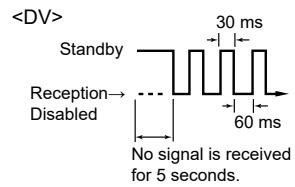
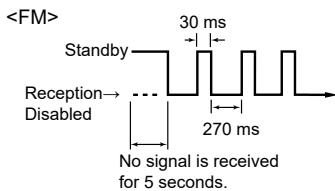

- Auto (Middle): Sets the Power saving time to "Middle."

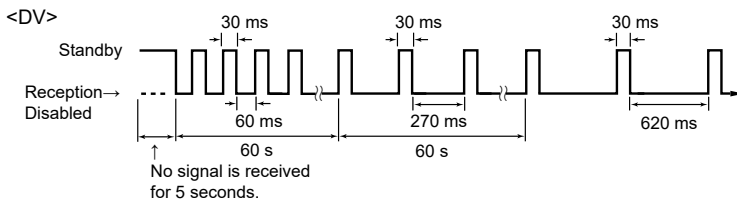
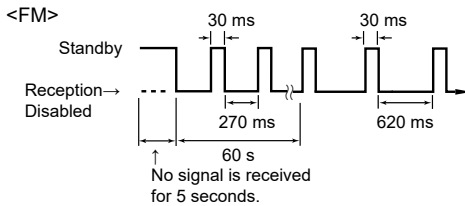

- Auto (Long): Sets the Power saving time to "Long."

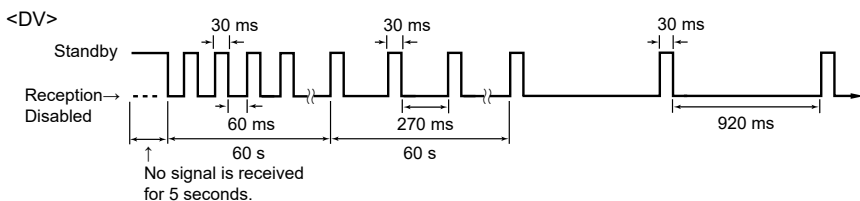
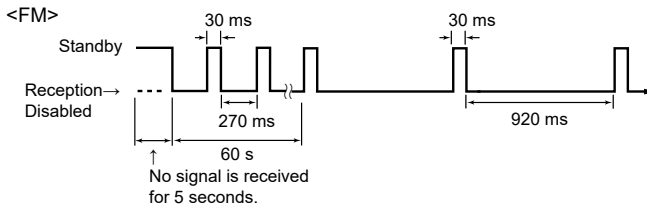



**Max TX Power (Battery Pack)** (Default: 5W)

Sets the maximum transmit power when using a battery pack to 0.5, 1, 2.5, or 5 W.

**Max TX Power (DC 13.8 V)** (Default: 10W)

Sets the maximum transmit power when connecting an external DC power supply to 0.5, 1, 2.5, 5, or 10 W.

**MENU** » **SET > Function > TX Delay**

**HF** (Default: OFF)

**50M** (Default: OFF)

**144M** (Default: OFF)

**430M** (Default: OFF)

Sets the TX delay time on each band.

① If an external equipment's rise time is slower than that of the IC-705, a reflected wave is produced, and it may damage the IC-705 or the external device. To prevent this, set the appropriate delay time so that no reflected wave or timing damage occurs.

① Select "OFF" for no delay.

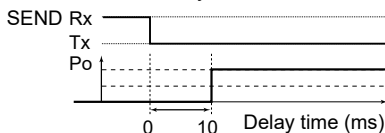

**MENU** » **SET > Function**

**Time-Out Timer** (Default: 5min)

Sets the Time-out Timer to OFF, 3, 5, 10, 20, or 30 minutes to prevent an accidental prolonged transmission.

① Select "OFF" for no time limit.

**PTT Lock** (Default: OFF)

Turns the PTT Lock function ON or OFF. To prevent accidental transmissions, this function inhibits all transmissions.

- OFF: Turns OFF the function.
- ON: Inhibits all transmissions.

**MENU** » **SET > Function > SPLIT**

**Quick SPLIT** (Default: ON)

Turns the Quick SPLIT function ON or OFF. This function automatically turns ON the SPLIT function, and sets the frequency and mode to the VFO that is not displayed (VFO A or AFO B), according to the SPLIT Offset setting.

- OFF: Turns OFF the function.
- ON: Turns ON the function.

**SPLIT Offset** (Default: 0.000 MHz)

Sets the SPLIT offset between -9.999 and +9.999 MHz. The SPLIT offset is the difference between the receive and transmit frequencies for the Quick SPLIT function.

**SPLIT LOCK** (Default: OFF)

Turns the Split Lock function ON or OFF.

The SPLIT LOCK function enables you to adjust the transmit frequency while holding down **XFC**, even while the Dial Lock function is activated.

To prevent accidentally changing the receive frequency by rotating **MAIN DIAL**, use both the SPLIT LOCK and Dial Lock functions (p. 3-8).

- OFF: Turns OFF the function.
- ON: Turns ON the function.

**MENU** » **SET > Function**

**Tuner (PTT Start)** (Default: ON)

Turns the PTT Start Tuning function ON or OFF. This function starts tuning when [PTT] is pushed if the operating frequency is shifted\* while the antenna tuner is ON.

- \* 1.9 ~ 10 MHz band: more than 0.5%
- 14 ~ 50 MHz band: more than 1%

**Auto Repeater** (Default: ON (DUP))

① This item is displayed in only the USA version.

The Auto repeater function automatically turns the duplex operation and tone encoder ON or OFF.

- OFF: Turns OFF the function.
- ON (DUP): Turns ON the duplex settings only.
- ON (DUP, TONE): Turns ON the duplex settings and the tone encoder function.

**RTTY Mark Frequency** (Default: 2125)

Selects the RTTY mark frequency.

① When the internal RTTY decoder is used, 2125 Hz is automatically selected.

**RTTY Shift Width** (Default: 170)

Selects the RTTY shift width.

① When the internal RTTY decoder is used, 170 Hz is automatically selected.

**RTTY Keying Polarity** (Default: Normal)

Selects the RTTY keying polarity.

- Normal: Key open/close = Mark/Space
- Reverse: Key open/close = Space/Mark

## Function

**[MENU]** » **SET > Function > SPEECH****SPEECH Language** (Default: English)

Sets the speech language to English or Japanese.

**Alphabet** (Default: Normal)

Selects the type of phonetic announcement.

**SPEECH Speed** (Default: Fast)

Sets the speech speed to Fast or Slow.

**RX Call Sign SPEECH** (Default: ON (Kerchunk))

Turns the RX Call Sign Speech function ON or OFF for calls received in the DV mode.

**RX>CS SPEECH** (Default: ON)

Turns the RX&gt;CS Speech function ON or OFF.



**MIC Up/Down SPEECH** (Default: OFF)

Turns the Microphone Up/Down Speech function ON or OFF.

- OFF: The frequency or repeater call sign is not announced.
- ON: The frequency or repeater call sign is announced, 1 second after pushing the microphone's [▲]/[▼] key. In the VFO, Memory, or Call channel mode, the frequency is announced. When using the DR function, the repeater call sign is announced.

**S-Level SPEECH** (Default: ON)

Turns the S-meter level announcement ON or OFF.

- OFF: The operating mode and the operating frequency are announced when you push .
- ON: The signal strength level, the operating mode, and the operating frequency are announced when you push .

**MODE SPEECH** (Default: OFF)





Turns the operating mode announcement ON or OFF.

- OFF: The selected operating mode is not announced.
- ON: The selected operating mode is announced.

**SPEECH Level** (Default: 50%)

Sets the Voice Synthesizer audio output level.

**[MENU]** » **SET > Function****[SPEECH/LOCK] Switch** (Default: SPEECH/LOCK)Selects  action.

- SPEECH/LOCK: Pushing  turns ON the Voice Synthesizer function. Holding down  turns the Lock function ON or OFF.
- LOCK/SPEECH: Pushing  turns the Lock function ON or OFF. Holding down  turns ON the Voice Synthesizer function.

**Lock Function** (Default: MAIN DIAL)This function electronically locks **(MAIN DIAL)** or the panel display\* to prevent accidental changes.\* Keys and dials are also locked except for **(POWER)** and .**Memo Pad Quantity** (Default: 5)

Sets the number of memo pad channels to 5 or 10.

**MAIN DIAL Auto TS** (Default: High)Sets the Auto Tuning Step function for **(MAIN DIAL)**.When rapidly rotating **(MAIN DIAL)**, the tuning step automatically changes according to the rotation speed.

- OFF: Auto tuning step is turned OFF.
- Low: Approximately two times faster.
- High: Approximately five times faster when the tuning step is set to 1 kHz or smaller. Approximately two times faster when the tuning step is set to 5 kHz or larger.

**MIC Up/Down Speed** (Default: Fast)

Selects the steps per second when changing an operating frequency by holding down the microphone's [▲]/[▼] key.

- Slow: Low speed (25 tuning steps/second)
- Fast: High speed (50 tuning steps/second)

**[NOTCH] Switch (SSB)** (Default: Auto/Manual)**[NOTCH] Switch (AM)** (Default: Auto/Manual)

Selects the Notch function used in the SSB or AM mode.

- Auto: Only the Auto Notch function can be used.
- Manual: Only the Manual Notch function can be used.
- Auto/Manual: Both the Auto and Manual Notch functions can be used.

**SSB/CW Synchronous Tuning** (Default: OFF)

Turns the Displayed Frequency Shift function ON or OFF.

This function automatically shifts the frequency to match the CW pitch when the operating mode is toggled between SSB and CW.

- OFF: Turns OFF the function.
- ON: When the operating mode is changed between SSB and CW, the operating frequency shifts by the offset amount.

**CW Normal Side** (Default: LSB)

Selects the carrier point in the CW normal mode.

- LSB: Sets the carrier point to the LSB side.
- USB: Sets the carrier point to the USB side.

**Battery Pack Select** (Default: BP-272)

Selects the model of the attached battery pack to display the optimized battery status.

**Battery Pack Confirmation** (Default: OFF)

Selects whether or not to display the Battery Pack Select dialog when the first time the transceiver is turned ON after reattaching a battery pack.

**Charging (Power ON)** (Default: ON)

Selects whether or not to charge the battery pack when an external power source is connected, even if the transceiver is ON.

**USB Power Input (Phone, Tablet, PC)**  
(Default: ON)

Selects whether or not to use a mobile device or a PC as an external power source.

**Power OFF Setting (for Remote Control)**  
(Default: Shutdown only)

Selects whether or not to display the Standby/Shutdown option dialog after holding down **[POWER]** for 1 second.

- Shutdown only: Shuts down the transceiver when you turn it OFF.
- Standby/Shutdown:  
Displays the Standby/Shutdown option dialog when you turn it OFF.

**[MENU] » SET > Function > Remote MIC Key**

**[A]** (Default: Home CH)  
**[B]** (Default: VFO/MEMO)  
**[△]** (Default: UP (VFO: kHz))  
**[▽]** (Default: DOWN (VFO: kHz))

The function assignments for the [A], [B], [△], and [▽] keys on the HM-243 SPEAKER MICROPHONE can be changed.

① See page 8-7 about the functions.

**Mode Select**

(Default:  SSB/ CW/ RTTY/  
 AM/ FM/ DV/ WFM)

Selects whether or not to enable to select the mode by pushing the microphone's key that "MODE" is assigned to.

① Displays "✓" when the mode is selectable.

① The settings are also used for the Bluetooth headset. When you change "Mode Select" in the "Function" menu or the "Bluetooth Set" menu, the other is automatically changed.

**[MENU] » SET > Function****Keyboard Type** (Default: Full Keyboard)

Sets the keyboard entry type to Ten-Key or Full Keyboard.

**Full Keyboard Layout** (Default: English)

Sets the on-screen keyboard layout from English, German, or French.

**Screen Capture [POWER] Switch** (Default: OFF)

Assigns the Screen Capture function to **[POWER]**.

- OFF: **[POWER]** does not act as the Screen Capture key.
  - ON: **[POWER]** acts as the Screen Capture key.
- ① When both "Screen Capture [POWER] Switch" and "Screen OFF [POWER] Switch" are set to ON, pushing **[POWER]** displays the dialog to select "Screen OFF" or "Screen Capture."

**Screen Capture File Type** (Default: PNG)

Sets the file format for the Screen Capture function to PNG or BMP.

**REF Adjust**

Adjusts the internal reference frequency.

**NOTE:** The default setting of "REF Adjust" may differ slightly, depending on the transceiver version.

The assignable key functions

Function	Description
---	No function
UP	Push to increase the frequency (in 50 Hz steps*), Memory channel, repeater, or select the next station call sign. * When the Tuning Step function is ON, increases the frequency in the selected Tuning Step.
DOWN	Push to decrease the frequency (in 50 Hz steps), Memory channel, repeater, or select the previous station call sign. * When the Tuning Step function is ON, increases the frequency in the selected Tuning Step.
UP (VFO: kHz)	Push to increase the frequency (in the selected Tuning Step), Memory channel, repeater, or select the next station call sign.
DOWN (VFO: kHz)	Push to decrease the frequency (in the selected Tuning Step), Memory channel, repeater, or select the previous station call sign.
VOL UP	Push to increase the volume level.
VOL DOWN	Push to decrease the volume level.
XFC	Hold down for 1 second to monitor signals.
CALL	Push to select the Call channel mode.
VFO/MEMO	<ul style="list-style-type: none"> <li>• Push to select the VFO mode and the Memory mode.</li> <li>• Hold down for 1 second to copy a Memory channel contents to the VFO.</li> </ul>
DR	Push to turn the DR function ON or OFF.
FROM/TO (DR)	<b>In the DR screen</b> Push to select "FROM" or "TO."
Home CH	Push to directly select the Home Channel that is set to the selected mode (VFO/Memory) or DR screen. ① While in the Call channel mode, or when no Home CH is set, an error beep sounds.
BAND/ GROUP UP	<b>In the VFO mode</b> <ul style="list-style-type: none"> <li>• Push to increase an operating band.</li> <li>• Hold down for 1 second to recall the Band Stacking Register contents.</li> </ul> <b>In the Memory mode</b> Push to increase the Memory group.
BAND/ GROUP DOWN	<b>In the VFO mode</b> <ul style="list-style-type: none"> <li>• Push to decrease an operating band.</li> <li>• Hold down for 1 second to recall the Band Stacking Register contents.</li> </ul> <b>In the Memory mode</b> Push to decrease the Memory group.
SCAN	<ul style="list-style-type: none"> <li>• Push to start the previously selected scan. While scanning, push to stop the scan.</li> <li>• Hold down for 1 second to open the SCAN SELECT screen.</li> </ul>

Function	Description
Temporary Skip	Push to set the frequency to be skipped while scanning. The selected frequencies are temporarily skipped for faster scanning.
SPEECH	Push to announce the frequency, operating mode, or call sign. ① In the VFO, Memory, or Call channel mode, the frequency and the operating mode are announced. ① In the DR screen, the call sign is announced. If Simplex is selected, the frequency is announced.
MODE	<ul style="list-style-type: none"> <li>• Push to select the operating mode.</li> <li>• Hold down to toggle USB and LSB, CW and CW-R, or RTTY and RTTY-R.</li> </ul>
RF Power	Push to adjust the transmit output power.
Voice TX (T1)	<ul style="list-style-type: none"> <li>• Push to transmit the voice audio recorded on the microSD card once.</li> <li>• Hold down for 1 second to repeatedly transmit the voice audio.</li> </ul>
Voice TX (T2)	<ul style="list-style-type: none"> <li>① This key function can also be used on the DR screen.</li> <li>① If the voice audio is not saved in the Voice TX memory (T1 or T2), this function is disabled.</li> </ul>
Keyer Memory (M1)	<ul style="list-style-type: none"> <li>• Push to transmit the Keyer memory contents once.</li> <li>• Hold down for 1 second to repeatedly transmit the memory contents.</li> </ul>
Keyer Memory (M2)	① If the Keyer memory contents (M1 or M2) is not entered, this function is disabled.
T-CALL	Push to transmit a 1750 Hz Tone. (Only for European version.)
RX>CS	<ul style="list-style-type: none"> <li>• Push to display the RX History list.</li> <li>• Hold down for 1 second to set the last calling station's call sign to "TO" (destination).</li> </ul>
TS	<ul style="list-style-type: none"> <li>• Push to turn the Tuning Step function ON or OFF.</li> <li>• Hold down for 1 second to open the TS screen.</li> </ul>
MPAD	<ul style="list-style-type: none"> <li>• Push to sequentially call up the contents in the Memo Pads.</li> <li>• Hold down for 1 second to save the displayed contents into the Memo Pad.</li> </ul>
SPLIT	<ul style="list-style-type: none"> <li>• Push to turn the Split function ON or OFF.</li> <li>• Hold down 1 second to turn ON the Quick Split function.</li> </ul>
A/B	<ul style="list-style-type: none"> <li>• Push to select the VFO A or VFO B.</li> <li>• Hold down for 1 second to set the displayed VFO's frequency to the VFO that is not displayed.</li> </ul>

## My Station

**MENU** » **SET > My Station**

### My Call Sign

The transceiver has a total of 6 memories to save your own call signs for use in the DV mode. You can enter a call sign of up to 8 digits. Also, a note of up to 4 characters, for operating transceiver type, area, and so on, can be entered.

### TX Message

The transceiver has a total of 5 memories to save short messages for simultaneous transmission in the DV mode. Enter a message of up to 20 alphanumeric characters for each memory.  
 ① To transmit no message, select "OFF."

## DV Set

**MENU** » **SET > DV Set**

### Standby Beep

(Default: ON (to me:Alarm/High Tone))

Turns the Standby Beep function ON or OFF. This function sounds a beep after a received signal disappears, in the DV mode.

- OFF: Does not sound a beep after a received signal disappears.
- ON: Sounds a beep after a received signal disappears.
- ON (to me:High Tone): Sounds a high pitched beep when a received signal that is addressed to your call sign (MY) disappears. When any other received signal disappears, a regular beep sounds.
- ON (to me:Alarm/High Tone): Sounds alarm (PiRoPiRoPiRo) when a received signal that is addressed to your call sign (MY) disappears. When any other received signal disappears, a regular beep sounds.

① The standby beep sounds even when "Key-Touch Beep" is set to "OFF."

① The standby beep output level depends on the Beep level setting.

### Auto Reply (Default: OFF)

Sets the Automatic Reply function to ON, OFF, Voice, or Position. This function automatically replies to a call addressed to your own call sign (MY), even if you are away from the transceiver.

- OFF: Turns OFF the function.
- ON: Replies with your own call sign (MY). (No audio reply is sent)
- Voice: Replies with your call sign (MY) and any Auto Reply message recorded on the microSD (up to 10 seconds). If no microSD card is inserted, or no message is recorded, only your call sign is transmitted. The transmitted audio can be monitored.
- Position: Replies with your own call sign and transmits your position data using the internal GPS receiver.
  - ① When "GPS Select" is set to "OFF" or "Manual," the internal GPS receiver is temporarily turned ON.
  - ① When "ON" or "Voice" is selected, the Automatic Reply function is automatically turned OFF when you push the microphone's [PTT].

### DV Data TX (Default: Auto)

Selects whether to manually or automatically transmit data in the DV mode.

- PTT: Push the microphone's [PTT] to manually transmit data.
- Auto: When data is input from a PC through the [microUSB] port, the transceiver automatically transmits it.

## DV Set

**MENU** » **SET > DV Set > DV Fast Data**

### **Fast Data** (Default: OFF)

Selects whether or not to use the DV Fast Data function for data communication in the DV mode. The DV Fast Data function uses the data and the audio frames to send data approximately 3.5 times faster than the normal speed. So, no audio can be sent.

- OFF: Sends data at a slow speed (approximately 950 bps).
- ON: Sends data at a fast speed (approximately 3480 bps).

① Even if "ON" is selected, when you push the microphone's [PTT], the data is sent at the slow speed, because the audio frame is used for the audio transmission.

The GPS data speed is set in "GPS Data Speed."

### **GPS Data Speed** (Default: Slow)

Sets the GPS data speed when the data is sent using the DV Fast Data function.

- Slow: Sends GPS data in the slow speed (approximately 950 bps).
- Fast: Sends GPS data in the fast speed (approximately 3480 bps).

### **TX Delay (PTT)** (Default: 2sec)

Sets the time for when the transceiver returns to receive after sending DV data in the DV Fast Data mode using the microphone's [PTT].

- OFF: After releasing [PTT], the transceiver returns to receive.
- 1 ~ 10sec: After releasing [PTT], the transceiver sends data using the DV Fast Data mode for this set period.  
When the TX data is completely sent within this set period, the transceiver automatically returns to receive.

**NOTE:** This function is usable only when "DV Data TX" is set to "PTT."

**MENU** » **SET > DV Set**

### **Digital Monitor** (Default: Auto)

Selects a receive mode when **XFC** is pushed in the DV mode.

- Auto: Receives in the DV mode or the FM mode, depending on the received signal.
- Digital: Receives in the DV mode.
- Analog: Receives in the FM mode.

### **Digital Repeater Set** (Default: ON)

Turns the Digital Repeater Set function ON or OFF. When accessing a repeater that has a call sign that is different than the transceiver's setting, this function reads the repeater's transmit signal and automatically sets the repeater call sign.

- OFF: Turns OFF the function.
- ON: Automatically sets the repeater call sign.

### **DV Auto Detect** (Default: OFF)

Turns the DV mode Automatic Detect function ON or OFF. When in the DV mode, if you receive a non-digital signal, this function automatically sets the operating mode to the FM mode.

- OFF: Turns the function OFF. The operating mode is fixed to the DV mode.
- ON: Automatically selects the FM mode for temporary operation.

### **RX Record (RPT)** (Default: ALL)

The transceiver can record the data of up to 50 individual calls. When the received signal includes a status message ("UR?" or "RPT?") that is sent back from the access repeater, you can record up to 50 messages, or only the last call, in the Received Call Record.

- ALL: Records up to 50 calls.
- Latest Only: Records only the last call.

### **BK** (Default: OFF)

The Break-in (BK) function enables you to break into a conversation, where the two other stations are communicating with call sign squelch enabled.

- OFF: Turns OFF the function.
- ON: Turns ON the function.

① The BK function is automatically turned OFF when the transceiver is turned OFF.

**EMR** (Default: OFF)

The Enhanced Monitor Request (EMR) function enables all transceivers that receive an EMR signal in the DV mode automatically open their squelch to receive the signal.

- OFF: Turns OFF the function.
- ON: Turns ON the function.

① The EMR function is automatically turned OFF when the transceiver is turned OFF.

**EMR AF Level** (Default: 50%)

Sets the audio output level when an EMR communication mode signal is received. When an EMR signal is received, the audio will be heard at the programmed level, or the transceiver's audio level, whichever is higher. To disable the setting, set to "0."

**NOTE:** After an EMR signal disappears, the audio level will remain at the EMR level. In this case, rotate **(AF/RF/SQL)** to adjust the audio level.

**QSO/RX Log**

**MENU** » **SET > QSO/RX Log**

**QSO Log** (Default: ON)

Selects whether or not to make a communication log on a microSD card. The communication log is made on a microSD card, and saved in the "csv" format.

① This function requires a microSD card (User supplied).

- OFF: The QSO Log function is OFF.
- ON: The transceiver makes a log on the microSD card. The transceiver starts making a log when you begin talking.

**TIP:**

- The folder name is automatically created, as [IC-705\QsoLog].
- The file name is automatically created, as shown in the example below:  
Log start date and time: 1st January 2020 15:30:00  
File name: 20200101\_153000.csv
- The log contents are not displayed on the transceiver.
- You can display the log contents on a PC.

**RX History Log** (Default: OFF)

Selects whether or not to make a DV mode's receive history log on a microSD card.

The receive history log is made on a microSD card, and saved in the "csv" format.

① This function requires a microSD card (User supplied).

- OFF: The RX History Log function is OFF.
- ON: The transceiver makes a DV mode's receive history log on the microSD card. The transceiver starts making a receive history log when you finish talking.

**TIP:**

- The folder name is automatically created, as [IC-705\RxLog].
- The file name is automatically created, as shown in the example below:  
Log start date and time: 1st January 2020 15:30:00  
File name: 20200101\_153000.csv
- The log contents are not displayed on the transceiver.
- You can display the log contents on a PC.

**MENU** » **SET > QSO/RX Log > CSV Format**

**Separator/Decimal** (Default: Sep[,.] Dec[.])

① The default value may differ, depending on the transceiver version.

Selects the separator and the decimal character for the CSV format.

- Sep [,] Dec [.]: Separator is "," and Decimal is "."
- Sep [.] Dec [.]: Separator is "." and Decimal is "."
- Sep [.] Dec [,]: Separator is "." and Decimal is ","

**Date** (Default: mm/dd/yyyy)

① The default value may differ, depending on the transceiver version.

Selects the date format between "yyyy/mm/dd," "mm/dd/yyyy," and "dd/mm/yyyy." (y: year, m: month, d: day)

## 8 SET MODE

The call log contents are shown below:

Contents	Example		Descriptions
TX/RX	TX	RX	Transmission and reception
Date	1/1/2020 13:51:48	1/1/2020 13:51:48	Date and time the call was started.
Frequency	438.010000	438.010000	Operating frequency
Mode	DV	DV	Operating mode (USB/USB-D/LSB/LSB-D/CW/CW-R/RTTY/ RTTY-R/AM/AM-D/FM/FM-D/WFM/DV)
My Latitude	34.764667	34.764667	Your latitude (unit: degrees) (+: North latitude, -: South latitude)
My Longitude	135.375333	135.375333	Your longitude (unit: degrees) (+: East longitude, -: West longitude)
My Altitude	50.5	50.5	Your altitude (unit: meters) Records to one decimal place.
RPT Call Sign	JP3YHJ	JP3YHJ A	Repeater call sign (DV mode only)
TX Call Sign	CQCQCQ	(Blank)	TX Call sign (DV mode only)
RX Call Sign	(Blank)	JA3YUAA/705	RX Call sign/Note (DV mode only)
RF Power	20%	(Blank)	TX output power level
S meter	(Blank)	S0	The relative signal strength of the receive signal (in 16 levels)
RX Latitude	(Blank)	34.764667	Caller's latitude, if sent. (unit: degrees) (+: North latitude, -: South latitude) Records only when you receive in the DV mode.
RX Longitude	(Blank)	135.375333	Caller's longitude, if sent. (unit: degrees) (+: East longitude, -: West longitude) Records only when you receive in the DV mode.
RX Altitude	(Blank)	30.5	Caller's altitude, if sent. (unit: meters) Records only when you receive in the DV mode.



The RX log contents are shown below:

Contents	Example	Descriptions
Frequency	438.010000	RX Frequency
Mode	DV	Operating mode (DV mode is fixed)
Caller	JA3YUAA	Call sign of the caller station (up to 8 characters)
/	705	Note after the call sign (up to 4 characters)
Called	CQCQCQ	Call sign of the called station
Rx RPT1	JP3YHH G	Access repeater call sign of the caller station, or the gateway repeater call sign of your local area repeater.
Rx RPT2	JP3YHH A	Access repeater call sign of the called station
Message	Hello CQ D-STAR!	Message included in the received call (up to 20 characters)
Status	(Blank)	Normal: blank, Uplink: "RPT UP", Access repeater reply: "UR?" or "RPT?"
Received date	1/1/2020 13:51:48	Date and time the call was received Depending on the setting, the format may differ.
BK	*	BK call: "**", Normal call: Blank
EMR	*	EMR call: "**", Normal call: Blank
Latitude	34.764667	Caller's latitude, if sent. (unit: degrees) (+: North latitude, -: South latitude)
Longitude	135.375333	Caller's longitude, if sent. (unit: degrees) (+: East longitude, -: West longitude)
Altitude	30.5	Caller's altitude, if sent. (unit: meters) Records to one decimal place.
SSID	-A	Caller's SSID, if sent. (0, -1 to -15, -A to -Z)
D-PRS Symbol	Car	Icon: Converts to text, None: Code
Course	123	Caller's course (unit: degrees)
Speed	23.5	Caller's speed (unit: km/h) Records to one decimal place.
Power	49	TX power (unit: watts)
Height	24	Antenna height (unit: meters)
Gain	6	Antenna gain (unit: dB)
Directivity	Omni	Antenna directivity (Omni, 45, 90, 135, 180, 225, 270, 315, or 360)
Object/Item Name	HAM FES	Object name or Item name (up to 9 characters)
Data Type	Live Object	Data type of Object or Item (Live or Kill)
Temperature	20.5	Temperature (unit: °C) Records to two decimal places.
Rainfall	253.75	Rainfall (unit: mm) Records to two decimal places.
Rainfall (24 Hours)	253.75	Rainfall (24 Hours) (unit: mm) Records to two decimal places.
Rainfall (Midnight)	253.75	Rainfall (Midnight) (unit: mm) Records to two decimal places.
Wind Direction	315	Wind Direction (unit: degrees)
Wind Speed	10.0	Wind Speed (unit: m/s) Records to one decimal place.
Gust Speed	10.0	Gust Speed (unit: m/s) Records to one decimal place.
Barometric	1013.0	Barometric (unit: hPa) Records to one decimal place.
Humidity	85	Humidity (unit: %)
GPS Time Stamp	12:00:00	Time data that the caller station acquires along with the position data
GPS Message	Osaka City/IC-705	Caller is "NMEA": Records the GPS message Caller is "D-PRS": Records the D-PRS comment

## Connectors

**MENU** » **SET > Connectors**

### **SP Jack Function** (Default: Speaker)

Selects the audio output from the [SP] jack.

- **Speaker:** The audio is output from only the Left channel through the amplifier for a speaker.
- **Phone:** The audio is output from only the Left channel through the amplifier for a headphone.
- **Phone (L+R):** The audio is output from the Right and Left channels through the amplifier for a headphone.

### **Phones Level** (Default: 0)

Sets the audio output level ratio of the headphone and internal speaker between -15 and +15.

**MENU** » **SET > Connectors > USB AF/IF Output**

### **Output Select** (Default: AF)

Selects the signal output from the [microUSB] port.

- **AF:** An AF signal is output.
- **IF:** A 12 kHz IF signal is output.

### **AF Output Level** (Default: 50%)

Sets the AF output level of the [microUSB] port, when "Output Select" of USB is set to "AF."

### **AF SQL** (Default: OFF (Open))

Selects whether or not to output the audio from the [microUSB] port, depending on the squelch state, when "Output Select" of USB is set to "AF."

- **OFF (Open):** The squelch is always open, regardless of the transceiver's squelch level.
- **ON:** The squelch opens and closes, depending on the transceiver's squelch level.

### **AF Beep/Speech...Output** (Default: OFF)

Sets the Beep and Speech audio output setting of the [microUSB] port, when "Output Select" of USB is set to "AF."

- **OFF:** The beep and speech audio are not output.
- **ON:** The beep and speech audio are output.

### **IF Output Level** (Default: 50%)

Sets the IF output level of the [microUSB] port, when "Output Select" of USB is set to "IF."

**MENU** » **SET > Connectors > WLAN AF/IF Output**

### **Output Select** (Default: AF)

Selects the signal output to the network.

- **AF:** An AF signal is output.
- **IF:** A 12 kHz IF signal is output.

### **AF SQL** (Default: ON)

Selects whether or not to output the audio to the network, depending on the squelch state, when "Output Select" of WLAN is set to "AF."

- **OFF (Open):** The squelch is always open, regardless of the transceiver's squelch level.
- **ON:** The squelch opens and closes, depending on the transceiver's squelch level.

**MENU** » **SET > Connectors > MOD Input**

### **USB MOD Level** (Default: 50%)

### **WLAN MOD Level** (Default: 50%)

Sets the modulation input level of each interface.

### **DATA OFF MOD** (Default: MIC,USB)

### **DATA MOD** (Default: USB)

In the SSB, AM, or FM mode, selects the connector(s) to input the modulation signal when the Data mode is OFF, or ON.

**MENU** » **SET > Connectors > SEND Output**

### **HF** (Default: ON)

### **50M** (Default: ON)

### **144M** (Default: ON)

### **430M** (Default: ON)

Selects whether or not to switch the SEND terminal output level of the [SEND/ALC] jack to the Low level when transmitting.

- **OFF:** Does not switch to Low level.
- **ON:** Switches to Low level.

**MENU** » SET > Connectors > **USB SEND/Keying**

**TIP:** This is the setting for the terminal used for data communication when you operate the transceiver using software on a PC. When you connect the transceiver to the PC with a USB cable, 2 COM ports are recognized on the PC. To confirm USB (A)/USB (B), open the COM port properties, and confirm the "Value" on the "Details" tab.

### **USB SEND** (Default: OFF)

Sets the USB terminal of the transceiver to receive the SEND signal from the software on the PC. Select the same terminal as the terminal set by the software.

① You cannot select the terminal which is already selected in the "USB Keying (CW)" or "USB Keying (RTTY)" item.

### **USB Keying (CW)** (Default: OFF)

Sets the USB terminal of the transceiver to receive the CW Keying signal from the software on the PC. Select the same terminal as the terminal set by the software.

① You cannot select the terminal which is already selected in the "USB SEND" or "USB Keying (RTTY)" item.

### **USB Keying (RTTY)** (Default: OFF)

Sets the USB terminal of the transceiver to receive the RTTY Keying signal from the software on the PC. Select the same terminal as the terminal set by the software.

① You cannot select the terminal which is already selected in the "USB SEND" or "USB Keying (CW)" item.

**MENU** » SET > Connectors > **External Keypad**

**VOICE** (Default: OFF)

**KEYER** (Default: OFF)

**RTTY** (Default: OFF)

Enables each memory (voice, keyer, RTTY) transmission using an external keypad.

**MENU** » SET > Connectors > **CI-V**

### **CI-V Address** (Default: A4)

Sets the CI-V address in hexadecimal code.

① "A4" is the default address of the IC-705.

### **CI-V Transceive** (Default: ON)

Turns the Transceive function ON or OFF.

- OFF: The status is not output.
- ON: The status is output. When you change a setting on the transceiver, the same change is automatically set on other connected transceivers or receivers, and vice versa.

### **CI-V USB Echo Back** (Default: OFF)

Turns the Data Echo Back function ON or OFF, when remotely controlling the IC-705 through the [microUSB] CI-V port.

**MENU** » SET > Connectors > **USB (B) Function**

### **USB (B) Function** (Default: OFF)

The transceiver has 2 virtual COM ports, A and B. In this item, sets the function to be assigned to USB (B).

① USB (A) is used for programming, or CI-V operation.

① When connecting to a USB port on your PC that is installed the USB driver, USB (A) and USB (B) are named as "IC-705 Serial Port A (CI-V)" and "IC-705 Serial Port B."

- OFF: Does not assign the function to USB (B).
- RTTY Decode: Outputs the decoded data of the RTTY signal.
- DV Data: Inputs or outputs low speed data for the DV mode.
- Weather: Inputs the weather data entries.

### **GPS Out** (Default: OFF)

Selects whether or not to output the position data to USB (B).

- OFF: Does not output the position data to USB (B).
- DATA→USB (B): Outputs the position data to USB (B).

① It is valid when "USB (B) Function" is set to "OFF" or "DV Data."

**MENU** » SET > **Connectors**

### **MIC Jack 8V Output** (Default: OFF)

Selects whether or not to output 8 V from the [MIC] jack.

- OFF: Output 3.3 V from the [MIC] jack.
- ON: Output 8 V from the [MIC] jack.

## Display

**MENU** » **SET > Display**

### LCD Backlight (Default: 50%)

Sets the LCD backlight brightness.

① When "(Auto Adjusting)" is displayed to the right of the screen title, the backlight brightness is automatically adjusted using the ambient light sensor. Touching [Auto Adjust] turns this function ON or OFF.

### Screen Saver (Battery Pack) (Default: 5min)

### Screen Saver (DC 13.8 V) (Default: 60min)

Sets the Screen Saver function when using the battery pack and using using an external DC power supply.

This function activates and automatically turns OFF the screen when no operation is performed for the preset period of time.

### Screen OFF [POWER] Switch (Default: ON)

Selects whether or not to turn OFF the screen by pushing **[POWER]**.

- OFF: Pushing **[POWER]** does not turn OFF the screen.

- ON: Pushing **[POWER]** turns OFF the screen.

① When both "Screen Capture [POWER] Switch" and "Screen OFF [POWER] Switch" are set to ON, pushing **[POWER]** displays the dialog to select "Screen OFF" or "Screen Capture."

### RX LED (Default: ON)

Selects whether or not to light the TX/RX indicator while receiving a signal, or the squelch is open. To conserve battery power, turn OFF this function.

① The indicator lights red while transmitting, regardless of the setting.

### Meter Peak Hold (Default: ON)

Turns the Meter Peak Hold function ON or OFF.

### Memory Name (Default: ON)

Turns the Memory name display in the Memory mode ON or OFF.

### Group Name Popup (Default: ON)

Selects whether or not to display the group name when you change the memory channel group.

### RX Call Sign Display (Default: Normal)

In the DV mode, selects whether or not to display the call sign and the message of the caller station when a call is received.

- OFF: Does not display the caller station's call sign and message.

- Normal: The caller station's call sign and message automatically scroll once, and then disappear.

- RX Hold: The caller station's call sign and message automatically scroll once, and then the call sign is displayed on the transceiver's display until the signal disappears.

- Hold: The caller station's call sign and message automatically scroll once, and then the call sign is displayed on the transceiver's display until the signal disappears.

When the signal disappears, the call sign and the message are each repeatedly displayed for 2 seconds.

① When "Normal," "RX Hold," or "Hold" is selected, and if the call sign and name of the caller station is programmed in your memory, the programmed name is displayed after displaying the call sign.

### RX Position Indicator (Default: ON)

Selects whether or not to display the indicator when position data is included in the signal received in the DV mode.

- OFF: No indicator is displayed, even though the position data is included in the received signal.

- ON: The indicator is displayed when the position data is included in the received signal.

① When "RX Call Sign Display" is set to "OFF," the indicator is not displayed, even though position data is included in the received signal.

### RX Position Display (Default: ON)

Selects whether or not to display in a dialog when the caller station's position data is included in the signal received in the DV mode.

- OFF: No data is displayed in a dialog.

- ON: When the caller station's position data is included in the signal, its data is displayed in a dialog.

① The time period to display the dialog depends on the "RX Position Display Timer" setting.

**RX Position Display Timer** (Default: 10sec)

Sets the RX position data's time period to display in a dialog.

- 5/10/15/30sec: Displays the caller's position for this set period of time.
- Hold: Displays the caller's position until you operate the transceiver.

**Reply Position Display** (Default: ON)

Selects whether or not to display the caller's position data when the data is included in the Auto Replay signal.

- OFF: Does not display the caller's position data.
- ON: Automatically displays the caller's position data.

**RX Picture Indicator** (Default: ON)

Selects whether or not to display the RX Picture Indicator when a picture is included in the received signal.

- OFF: No indicator is displayed, even if a picture is included in the received signal.
- ON: The indicator is displayed when a picture is included in the received signal.

① When "RX Call Sign Display" is set to "OFF," the indicator is not displayed, even if a picture is included in the received signal.

**DV RX Backlight** (Default: ON)

Turns the DV RX Backlight function ON or OFF. In the DV mode, this function turns ON the backlight while displaying the calling station's call sign or a received message.

- OFF: The function is OFF.
- ON: The backlight automatically lights when displaying the calling station's call sign or a received message. The backlight stays ON while the call sign or message is scrolling.

**TX Call Sign Display** (Default: Your Call Sign)

Selects whether or not to display My or Your call sign while transmitting.

- OFF: Turns the function OFF.
- Your Call Sign: Displays and scrolls the call sign of the target station.
- My Call Sign: Displays and scrolls your own call sign.

① When "Your Call Sign" is selected, and if the call sign and name of the caller station is programmed in your memory, the programmed name is displayed after the call sign.

**Scroll Speed** (Default: Fast)

Sets the scrolling speed of the message, call sign, or other text, that are displayed on the transceiver's LCD to "Slow" or "Fast."

**Opening Message** (Default: ON)

Selects whether or not to display the opening message at power ON.

**Power ON Check** (Default: ON)

Selects whether or not to display the RF Power level and the power source voltage at power ON.

① When the external DC power source voltage is above 15.6V, "HI Voltage" is displayed.

**MENU** » **SET > Display > Display Unit**

**Latitude/Longitude** (Default: ddd° mm.mm')

Selects the format to display the position data.

**Altitude/Distance** (Default: ft/mi)

① The default value may differ, depending on the transceiver version.

Selects the format to display the distance and elevation.

**Speed** (Default: mph)

① The default value may differ, depending on the transceiver version.

Selects the format to display the speed.

**Temperature** (Default: °F)

① The default value may differ, depending on the transceiver version.

Selects the format to display the temperature.

**Barometric** (Default: inHg)

① The default value may differ, depending on the transceiver version.

Selects the format to display the barometric pressure.

**Rainfall** (Default: inch)

① The default value may differ, depending on the transceiver version.

Selects the format to display the amount of rainfall.

**Wind Speed** (Default: mph)

① The default value may differ, depending on the transceiver version.

Selects the format to display the wind speed.

Display

**MENU** » **SET > Display**

**Display Language** (Default: English)

① This item is displayed only when the “System Language” item is set to “Japanese.”

Sets the screen display language type to English or Japanese.

**System Language** (Default: English)

Sets the system language of the transceiver.

- English: The system language of the transceiver is English. Only alphabetical characters (A to Z, a to z, 0 to 9) and symbols (! “ # \$ % & ‘ ( ) \* + , - . / : ; < = > ? @ [ \ ] ^ \_ ` { | } ~) can be displayed. If Japanese characters (Kanji, Hiragana, and Katakana) are included, the display shows “=” or “\_” instead of that character. In that case, you can only delete “=” or “\_” in the transceiver’s edit mode.
- Japanese: The system language of the transceiver is Japanese. Kanji, Hiragana, and Katakana characters, and the 2-bytes symbols can be displayed. To display such characters in the DR screen or Menu mode, set “Display Language” to “Japanese.”

① When this item is set to “English,” “Display Language” is not displayed.

When you set the system language of the transceiver to Japanese, the transceiver has the capability to display both English and Japanese characters. HOWEVER, if you select Japanese, all menu items throughout the transceiver system will be displayed in only Japanese characters. There will be no English item names. Unless you are fluent in reading Japanese characters, use this feature with extreme caution. If you have change the transceiver’s language to Japanese and do not understand the menu system in the new setting, you will have to change the language back to English by doing a partial reset of the transceiver CPU. A partial reset will not clear your call sign databases.

To do a partial reset of the CPU, do the following steps:

1. Push **MENU**.
2. Touch **[SET]**.
3. Touch the item (with the “etc” icon) shown below.



4. Touch the bottom item shown below.



5. Touch the upper item shown below.



6. Touch the left item.

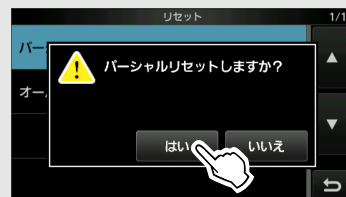

- The transceiver displays “PARTIAL RESET,” then the partial reset is completed.

## Time Set

**MENU** » SET > Time Set > **Date/Time**

### Date

Sets the date (Year/Month/Day).

① The day of the week is automatically set.

### Time

Sets the current time.

① The time is displayed in the 24 hour format.

### <<NTP TIME SYNC>>

Synchronizes the internal clock with the time management server.

① To use this function, you need an Internet connection and default gateway settings.

### NTP Function (Default: ON)

Automatically obtains the current time from the NTP server.

### NTP Server Address (Default: time.nist.gov)

Sets NTP server address.

### GPS Time Correct (Default: Auto)

Selects whether or not the time data is automatically corrected by a received GPS sentence.

**MENU** » SET > **Time Set**

### UTC Offset (Default: ±0:00)

Sets the UTC offset time.

## Bluetooth Set

**MENU** » SET > **Bluetooth Set**

### Bluetooth (Default: OFF)

Turns the Bluetooth function ON or OFF.

### Auto Connect (Default: ON)

Selects whether or not to automatically connect to the paired Bluetooth device when its power is turned ON.

- OFF: Does not connect to the paired device.
- ON: Automatically connects to the last connected device.

### Pairing/Connect

Searches for the Bluetooth device to connect, or display the paired Bluetooth devices in the list. See the Advanced Manual for details.

### <<Pairing Reception>>

Enters the pairing reception mode.

See the Advanced Manual for details.

**MENU** » SET > Bluetooth Set > **Headset Set**

### AF Output (Default: Headset Only)

Selects the AF Output device when a Bluetooth headset is connected.

- Headset Only: Outputs audio to only the connected Bluetooth headset.
- Headset & Speaker: Outputs audio to both the connected Bluetooth headset and the transceiver's speaker.

### Auto Disconnect (Default: OFF)

Sets the Disconnect Timer between 0 and 10 seconds, or OFF.

If there is no audio output from the Bluetooth headset, and there is no key operation for this set period of time, the Synchronous Connection-Oriented (SCO) link\* is automatically disconnected.

① The SCO link is connected when the signal is received, a beep sounds, or there is a key operation.

\* A Bluetooth link for voice communication

**Bluetooth Set**

**MENU** » SET > **Bluetooth Set**

**Headset Function Select** (Default: Normal)

Selects the PTT and microphone combination when both the Bluetooth headset and the transceiver microphone are used.

- Normal: Transmits the audio from the Bluetooth headset, or the transceiver microphone, whichever [PTT] is pushed.
- Microphone: Transmits the audio from the Bluetooth headset. Transmission is enabled by pushing either the [PTT] on the Bluetooth headset, or the transceiver microphone. The transceiver microphone is only used for the PTT control.
- PTT: Transmits the audio from the transceiver microphone. Transmission is enabled by pushing either the [PTT] on the Bluetooth headset, or the transceiver microphone. The Bluetooth headset is only used for the PTT control.

**NOTE: DO NOT** select “PTT” when the microphone is not connected to the transceiver, and you use only the Bluetooth headset.

① The Bluetooth headset operation for each option is listed below.

Option	TX control	TX audio
Normal	Enabled	Enabled
Microphone	Enabled	Enabled
PTT	Enabled	Disabled (Audio from the microphone is transmitted.)

**MENU** » SET > Bluetooth Set > Headset Set > **Icom Headset**

**Power Save** (Default: OFF)

Selects whether or not to operate with the Power Save mode while the optional VS-3 headset is connected.

- ① When a headset (user supplied) or a data device is connected, the Power Save mode is automatically turned OFF, regardless of this setting.
- OFF: Turns OFF the function.
- ON: The Power Save mode is enabled when no communication or operation is performed for 120 seconds.

**One-Touch PTT** (Default: OFF)

Sets the One-Touch PTT function when the optional VS-3 headset is connected.

This function enables you to transmit without continuously holding down [PTT].

① When a headset (user supplied) is connected, this function is automatically turned ON, regardless of this setting.

- OFF: Transmits while holding down [PTT].
- ON: Pushing [PTT] toggles between transmit and receive.

**PTT Beep** (Default: OFF)

Sets the beep sound when you push [PTT] on the optional VS-3 headset.

- OFF: No beep sounds.
- ON: A beep sounds.

**Custom Key Beep** (Default: OFF)

Sets the beep sound when you push the Custom Key ([PLAY]/[FWD]/[RWD]) on the optional VS-3 headset.

- OFF: No beep sounds.
- ON: A beep sounds.

**MENU** » SET > Bluetooth Set > Headset Set > Icom Headset > **Custom Key**

**[PLAY]** (Default: Home CH)

**[FWD]** (Default: UP (VFO: kHz))

**[RWD]** (Default: DOWN (VFO: kHz))

Assigns the functions to the Custom Key ([PLAY]/[FWD]/[RWD]) on the optional VS-3 headset.

① See page 8-7 about the functions.

**Mode Select**

(Default:  SSB/ CW/ RTTY/  
 AM/ FM/ DV/ WFM)

Selects whether or not to enable to select the mode by pushing the headset’s key that “MODE” is assigned.

① Displays “✓” when the mode is selectable.

① The settings are also used for the microphone. When you change “Mode Select” in the “Function” menu or the “Bluetooth Set” menu, the other is automatically changed.



**MENU** » SET > Bluetooth Set > **Data Device Set**

### Serialport Function

(Default: CI-V (Echo Back OFF))

Sets the serial port function for the Bluetooth SPP (Serial Port Profile) connection to a data device, PC, and so on.

- CI-V (Echo Back OFF):
  - Transmits or receives a CI-V command.
  - Does not send back the serial data received from the SPP connection.
- CI-V (Echo Back ON):
  - Transmits or receives a CI-V command.
  - Sends back the serial data received from the SPP connection.
- DV Data: Transmits or receives data in the DV mode.
  - Does not input the cloning or weather data entries, or output the GPS data.

**MENU** » SET > **Bluetooth Set**

### Bluetooth Device Information

Displays the Bluetooth device information.

### Initialize Bluetooth Device

Initializes the installed Bluetooth unit.

## WLAN Set

**MENU** » SET > **WLAN Set**

### WLAN (Default: OFF)

Turns the Wireless LAN function ON or OFF.

**MENU** » SET > WLAN Set > **Connection Settings**

### Access Point

Displays the Access Point to connect.

① See the Advanced Manual for details.

**MENU** » SET > WLAN Set > Connection Settings > **Manual Connect**

### SSID (Default: (blank))

Enter the SSID that is programmed in the Access Point.

### Security Type (Default: WPA/WPA2)

Sets the security type to connect to the Access Point to None, WEP, or WPA/WPA2.

① Select the same security type as the Access Point, otherwise you cannot communicate with it.

### Password (Default: (blank))

When "Security Type" is set to "WEP" or "WPA/WPA2," enters the WEP key or PSK key of the Access Point.

### <<Connect>>

After setting "SSID," "Security Type," and "Password," touch to connect to the Access Point.

**MENU** » SET > WLAN Set > **Connection Settings**

### DHCP (Valid after Restart) (Default: ON)

Turns the DHCP function ON or OFF.

- OFF: Uses a static IP address.
- ON: Uses the DHCP function.
  - If a DHCP server is in your network environment, the IP address is automatically obtained.

### IP Address (Valid after Restart)

(Default: 192.168.0.10)

Sets the static IP address.

## WLAN Set

**MENU** » SET > WLAN Set**Subnet Mask (Valid after Restart)**  
(Default: 255.255.255.0(24 bit))

Sets the subnet mask to connect to your PC or Local Area Network (LAN), through your Router.

**Default Gateway (Valid after Restart)**  
(Default: . . . .)

Sets the Default Gateway of the IC-705. When you remotely control the IC-705 or use the Internal Gateway function, a Default Gateway setting is required.

**Primary DNS Server (Valid after Restart)**  
(Default: . . . .)

Sets the Primary DNS Server address.

**2nd DNS Server (Valid after Restart)**  
(Default: . . . .)

If there are two DNS server addresses, sets the secondary DNS server address.

**MENU** » SET > WLAN Set**Network Name**

If you are operating the IC-705 using the optional RS-BA1 or transferring a picture to the IC-705 using the optional ST-4001W, enter a network name of up to 15 characters.

**MENU** » SET > WLAN Set > Remote Settings**Network Control (Valid after Restart)**  
(Default: OFF)

Selects whether or not to remotely control the IC-705.

- OFF: Disables remote control of the IC-705.
- ON: Enables remote control of the IC-705.

**Control Port (UDP) (Valid after Restart)**  
(Default: 50001)

Sets a port number for the control signal transfers between the IC-705 and the remote station, when you remotely control the IC-705.

**Serial Port (UDP) (Valid after Restart)**  
(Default: 50002)

Sets a port number for the serial data transfers between the IC-705 and the remote station, when you remotely control the IC-705.

**Audio Port (UDP) (Valid after Restart)**  
(Default: 50003)

Sets a port number for the audio signal transfers between the IC-705 and the remote station, when you remotely control the IC-705.

**Internet Access Line (Valid after Restart)**  
(Default: FTTH)

Selects the Internet access line setting for the IP remote control.

**MENU** » SET > WLAN Set > Remote Settings > Network User1**MENU** » SET > WLAN Set > Remote Settings > Network User2**Network User1 ID**  
**Network User2 ID**

Sets a user name of up to 16 characters to use when you remotely control the IC-705.

**Network User1 Password**  
**Network User2 Password**

Sets a user password.

- ① The password must include a minimum of 8 characters and a maximum of 16 characters.
- ① You cannot use a password that consists of exactly the same characters.

**Network User1 Administrator** (Default: NO)  
**Network User2 Administrator** (Default: NO)

Selects whether or not to set the user as an administrator.

Only an authorized user can disconnect communication between the IC-705 and the remote station.

**MENU** » SET > WLAN Set > Remote Settings**Network Radio Name** (Default: IC-705)

Sets the IC-705's name of up to 16 characters that is displayed in the remote control software, when you remotely control the IC-705.

## SD Card

**MENU** » SET > SD Card

### Load Setting

Selects the saved data file to load.

### Save Setting

Saves the setting data onto a microSD card.

**MENU** » SET > SD Card > Import/Export

### Import

Import the UR call sign, repeater list, or GPS memory data in the CSV format file.

### Export

Export the UR call sign, repeater list, or GPS memory data in the CSV format file.

**MENU** » SET > SD Card > Import/Export > CSV Format

### Separator/Decimal (Default: Sep [,] Dec [.] )

① The default value may differ, depending on the transceiver version.

Selects the separator and the decimal character for the CSV format.

- Sep [,] Dec [.]: Separator is “,” and Decimal is “.”
- Sep [;] Dec [;]: Separator is “;” and Decimal is “.”
- Sep [;] Dec [,]: Separator is “;” and Decimal is “,”

### Date (Default: mm/dd/yyyy)

① The default value may differ, depending on the transceiver version.

Selects the date format from “yyyy/mm/dd,” “mm/dd/yyyy,” and “dd/mm/yyyy.”

(y: year, m: month, d: day)

**MENU** » SET > SD Card

### Opening Picture

Selects the picture that is displayed at power ON.  
① See the Advanced Manual for details.

### SD Card Info

Displays the microSD card capacity and the time remaining for voice recording.

### Screen Capture View

Displays the selected screen capture.

### TX/RX Picture View

Displays the pictures that are saved on the microSD card.

- ① The transceiver cannot display the picture while transmitting picture data.
- ① The transceiver can display up to 500 pictures.

### Firmware Update

Displays the Firmware Update mode.

### Format

Formats the microSD card.

If you use a brand new microSD card, be sure to format it in the transceiver.

### Unmount

Unmounts the microSD card.

Before you remove a card when the transceiver is ON, be sure to electrically unmount it. Otherwise, the data may be corrupted or deleted.

## Others

**MENU** » SET > Others > **Information**

### Voltage

Displays the voltage of the battery pack and external power source.

- ① When you attach the Li-ion battery pack, the charge status of the battery pack and the battery voltage are displayed.
- ① Touching [SET] opens the BATTERY SET screen, and you can set "Battery Pack Select" and "Battery Pack Confirmation." (p. 8-6)

### Version

Displays the transceiver firmware's version number.

### MAC Address

Displays the transceiver's MAC address.

**MENU** » SET > Others > **Clone**

### Clone Mode

Selects to enter the clone mode to read or write the CS-705 data from or to the PC.

- ① Restart the transceiver to cancel the clone mode.

**MENU** » SET > **Others**

### Touch Screen Calibration

Touch to adjust the touch screen.

- ① See the Advanced Manual for details.

**MENU** » SET > Others > **Reset**

### Partial Reset

Resets operating settings to their default values (VFO frequency, VFO settings, menu contents) without clearing the items below:

- Memory channel contents
  - Keyer memory contents
  - RTTY memory contents
  - Call sign memories
  - Message contents
  - DTMF memory contents
  - GPS memory contents
  - Repeater list contents
  - WLAN settings
  - REF Adjust
  - User Band Edges
  - Fixed Edges
  - Allowed call sign list contents
  - Bluetooth pairing list
  - Opening picture
- ① See page 10-2 for details.

### All Reset

Clears all data and returns all settings to their factory defaults.

Memory channel contents, filter setting, and so on will all be cleared, so you will need to rewrite your operating settings.

- ① See page 10-2 for details.

## Setting the date and time

### ◇ Setting the date

1. Open the “Date” screen.  
 [MENU] » [SET > Time Set > Date/Time > **Date**]
2. Touch [+] or [-] to set the date.
3. Touch [SET] to save the date.

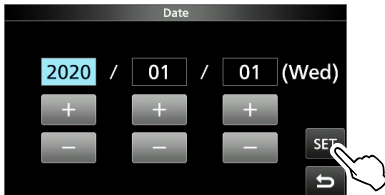

4. To close the DATE/TIME screen, push [EXIT] several times.

### ◇ Setting the current time

1. Open the “Time” screen.  
 [MENU] » [SET > Time Set > Date/Time > **Time**]
2. Touch [+] or [-] to set the current time.
3. Touch [SET] to save the time.

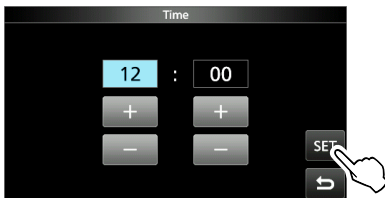

4. To close the DATE/TIME screen, push [EXIT] several times.

### ◇ Setting the UTC offset

1. Open the “UTC Offset” screen.  
 [MENU] » [SET > Time Set > **UTC Offset**]
2. Touch [+] or [-] to set the UTC offset.
3. Touch [SET] to save the UTC offset.

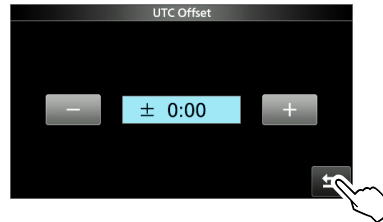

4. To close the TIME SET screen, push [EXIT] several times.

### NOTE: The backup battery for the internal clock

The IC-705 has a rechargeable Lithium battery to backup the internal clock. If you connect the transceiver to a power source, the battery is charged and it keeps the correct clock setting. However, if you do not attach the battery pack, or do not connect the transceiver to a power source for a long period of time, the battery will discharge. In that case, the transceiver resets the internal clock.

The battery is charged while connecting to a power source, whether the transceiver's power is ON or OFF.

# 10 MAINTENANCE

## Cleaning



**DO NOT** use harsh solvents such as benzine or alcohol when cleaning, because they will damage the transceiver surfaces.



If the transceiver becomes dusty or dirty, wipe it clean with a dry, soft cloth.

## Replacing fuse

A fuse is installed in each fuse holder of the supplied DC power cable, to protect the transceiver.

If the transceiver does not turn ON because a fuse blows, find and repair the cause of the problem. Then replace any blown fuse with a new, adequately rated fuse. (FGB 4 A)

① Spare fuses are supplied with the transceiver.

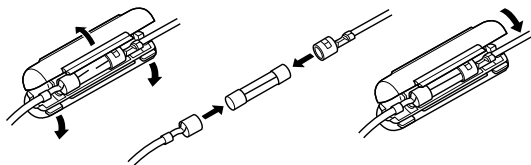

### ⚠ WARNING!

- Disconnect the DC power cable from the external power source before replacing the fuse.
- **NEVER** use fuses other than specified ones.

## Resetting

Occasionally, erroneous information may be displayed. This may be caused by static electricity or by other factors.

If this problem occurs, turn OFF the transceiver. After waiting a few seconds, turn ON the transceiver again.

If the problem still exists, perform a **Partial reset**, as described to the right.

If the problem still exists after a Partial reset, perform an **All reset**, also described to the right.

**NOTE:** An All reset clears all data and returns all settings to their factory defaults. Save memory channel content, setting status, and so on, onto a microSD card before an All reset. (p. 6-2)

### After performing a Partial reset

A Partial reset resets operating settings to their default values (VFO frequency, VFO settings, menu contents) without clearing the items listed below:

- Memory channel contents
- Keyer memory contents
- RTTY memory contents
- Call sign memories
- Message contents
- DTMF memory contents
- GPS memory contents
- Repeater list contents
- WLAN settings
- REF Adjust
- User Band Edges
- Fixed Edges
- Allowed call sign list contents
- Bluetooth pairing list
- Opening picture

### After performing an All reset

An All reset clears all data and returns all settings to their factory defaults. Memory channel contents, filter settings, and so on will all be cleared, so you will need to rewrite your operating settings unless you have a backup.

Resetting

◇ **Partial reset**

1. Open the RESET screen.  
[MENU] » [SET > Others > Reset]
2. Touch “Partial Reset.”



3. Touch [YES].

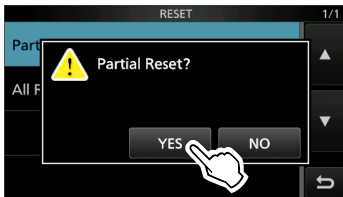

① After resetting, the default VFO mode screen is displayed.

◇ **All reset**

1. Open the RESET screen.  
[MENU] » [SET > Others > Reset]
2. Touch “All Reset.”

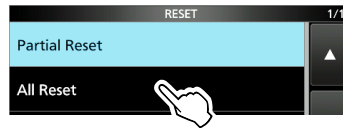

3. Touch [NEXT].

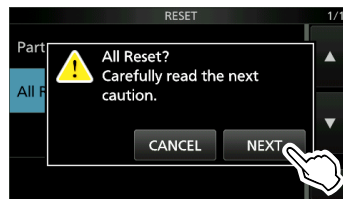

4. After carefully reading the displayed message, touch [YES] to perform the All reset.



① After resetting, the default VFO mode screen is displayed.

**When you cannot enter the Set mode**

If a touch screen operation error or an unexpected operation occurs, you cannot enter the Set mode. In this case, perform an All reset, as described below:

1. Turn OFF the transceiver.
2. While holding down [RIT/ΔTX] and [XFC], push [POWER].

## Troubleshooting

The following chart is designed to help you solve problems that are not equipment malfunctions. If you are unable to locate the cause of a problem or solve it through the use of this chart, contact your nearest Icom Dealer or Service Center.

① See the Advanced Manual for the problems when communicating through a repeater.

② "AM" indicates the PDF type Advanced Manual.

Problem	Possible Cause	Solution	REF.
Power does not turn ON when <b>POWER</b> is pushed.	The battery pack is exhausted.	Charge the battery pack.	p. 1-2
	Loose connection of a battery pack.	Clean the battery pack terminals.	—
	The power cable is not connected properly.	Reconnect the DC power cable properly.	p. 13-1
	The external power supply is turned OFF.	Turn ON the external power supply.	—
	A DC power cable fuse is blown.	Find and repair the cause of the problem, and then replace the damaged fuse with a new one.	p. 10-1
No sound is heard from the speaker.	The audio level is too low.	Rotate <b>(AF/RF/SQL)</b> clockwise to obtain a suitable listening level.	p. 3-1
	The squelch is closed.	Adjust the squelch level.	p. 3-8
	The external speaker is connected.	Disconnect the external speaker.	—
	The Bluetooth headset is connected.	Disconnect the Bluetooth headset.	AM
	In the FM mode, the Tone Squelch function is turned ON.	Turn OFF the Tone Squelch function.	AM
Sensitivity is too low, and only strong signals are heard.	The Attenuator is activated.	Turn OFF the Attenuator.	p. 4-1
	RF gain control is set too low. ("RFG" is displayed.)	Set the RF gain higher until "RFG" just goes off.	p. 3-8
	The antenna is defective, or the coaxial cable is defective.	Repair the problem and then reconnect the antenna.	—
	You are using an antenna that is not suitable for the band you have selected.	Connect an antenna suitable for the operating band.	p. 13-3
		Connect an external antenna tuner, and tune the antenna.	—
The squelch is closed.	Adjust the squelch level.	p. 3-8	
The transceiver automatically switches to transmit while receiving.	The VOX function is ON.	Push <b>(VOX)</b> to turn OFF the VOX function.	AM
	The VOX gain is set too high.	Adjust the VOX gain.	
No power output or the output power is too low.	The operating frequency is outside a ham band.	Set the frequency to a ham band.	p. 3-3
	The battery pack is exhausted.	Charge the battery pack.	p. 1-2
	The transmit output power is set too low.	Adjust the RF POWER in the Multi-function menu.	p. 3-9
	The modulation input signal level is set too low.	Adjust the MIC GAIN level in the Multi-function menu.	p. 3-10
	The output power is limited because of power amplifier protection.	Stop transmitting, and then wait until the temperature of the power amplifier FET drops sufficiently.	AM



Troubleshooting

Problem	Possible Cause	Solution	REF.
No power output or the output power is too low.	The microphone is bad, or the [MIC] jack is shorted or defective.	Test the microphone and check the [MIC] jack.	p. 13-3
	The antenna SWR is more than 3:1.	Adjust the antenna for an SWR of less than 3:1.	AM
	The antenna is not properly tuned.	Connect an external antenna tuner, and tune the antenna.	—
The transmit signal is unclear or distorted in the SSB mode.	The transceiver's microphone gain is too high.	Adjust the MIC GAIN level so that the meter reading swings between 30 and 50% of the ALC scale.	p. 3-10
The received audio in the SSB mode is unclear or distorted.	The incorrect sideband is selected.	Toggle between USB and LSB.	p. 3-2
	The PBT function is activated.	Hold down <b>(TWIN PBT)</b> to clear the settings.	p. 4-4
Cannot contact with another station, even if receiving and transmitting seem normal.	The Split function is ON, and the transmit and receive frequencies are different. ( <b>(SPLIT)</b> is displayed.)	Touch [SPLIT] in the FUNCTION screen to turn OFF the Split function.	p. 4-11
	The RIT function or the ΔTX function is ON, and the transmit and receive frequencies are different. ("RIT" or "ΔTX" is displayed.)	Push <b>(RIT/ΔTX)</b> to turn OFF the function.	p. 4-2
There is no response after transmitting.	The Duplex function is ON, and the transmit and receive frequencies are different.	Touch [DUP] several times in the FUNCTION screen to turn OFF the Duplex function.	AM
The operating frequency does not change when rotating <b>(MAIN DIAL)</b> .	The Dial Lock function is ON.	Hold down <b>(SPEECH)</b> to turn OFF the Dial Lock function.	p. 3-8
In the VFO mode, the operating frequency is not properly changed by rotating <b>(MULTI)</b> .	The function assigned to <b>(MULTI)</b> is wrong.	Push <b>(RIT/ΔTX)</b> to turn OFF the RIT or ΔTX function.	p. 4-2
		Hold down <b>(MULTI)</b> to assign the kHz Tuning Control or Select the Memory Channel function.	p. 2-8
The display turns OFF.	The Screen Saver function is ON. (The POWER indicator blinks green.)	Operate something (push key, and so on) to reset the screen saver startup time.	p. 8-15
The backlight brightness automatically changes.	The Auto Adjust function is ON.	Touch [Auto Adjust] in the "LCD Backlight" screen to turn OFF the Auto Adjust function. ("Auto Adjusting" disappears.)	p. 8-15
A Programmed scan does not start.	The same frequencies have been set in the scan edges (00 ~ 24).	Set different frequencies in the scan edges.	AM
A Memory scan does not start.	No, or only 1 memory channel is set.	Set at least 2 memory channels.	AM
A Select memory scan does not start.	No, or only 1 memory channel is assigned as a Select channel.	Assign at least 2 memory channels as Select channels for the scan.	AM

## Troubleshooting

Problem	Possible Cause	Solution	REF.
While operating in the Memory mode, you changed the operating frequency, mode, and so on, but a selected memory channel contents are not changed.	They were not overwritten already in the selected memory.	When you want to save the changed settings, touch [MW] for 1 second to write them into the memory channel on the VFO/MEMORY screen.	AM
Cannot hear the speech after pushing  .	The speech level is too low.	Adjust "SPEECH Level" in the Speech setting.	p. 8-5
"OVF" is displayed.	An excessively strong signal is being received.	Set the RF gain lower. ("RFG" is displayed.)	p. 3-8
		Turn ON the Attenuator.	p. 4-1
		Turn OFF the Preamplicifier (P.AMP OFF).	p. 4-1
The spectrum scope's sensitivity is too low, and only strong signals are displayed.	The reference level is too low.	Set the reference level to a higher level.	p. 5-1
Cannot transmit voice memories.	"DATA OFF MOD" is set to "USB" or "WLAN" by control from an external device, and so on.	Set "DATA OFF MOD" to "MIC,USB" (default) or "MIC."	p. 8-13
Cannot save TX/RX histories or sound data.	A microSD card is not inserted.	Insert a microSD card.	p. 6-1
"No SD Card is found." is displayed.	A microSD card is not recognized.	Confirm that a microSD card is inserted.	p. 6-1
		Reinsert a microSD card.	
		Exchange with a new microSD card.	
"– No File –" is displayed on the FIRMWARE UPDATE screen.	The firmware file is in an incorrect folder.	Copy the firmware file into the IC-705 folder.	AM
	The firmware file name is different.	Download the firmware file again.	
	The microSD card is not formatted.	Format the microSD card.	p. 6-1
The touch screen is not working correctly.	The touched point and the detected point may be different.	Calibrate the touch screen on the OTHERS screen.	AM
The current time is reset.	The transceiver has not been used for a long time, with the battery detached or the DC power cable disconnected.	Connect the transceiver to the power source to charge the backup battery of the internal clock.	p. 9-1
Even when turning ON the NTP function, the clock is not automatically set.	The transceiver is not connected to the Internet.	Confirm the network settings.	AM
	The transceiver IP address is wrong.	Turn ON the DHCP function to automatically get the IP address, or set the correct IP address.	p. 8-20

## ◇ General

• Frequency coverage (unit: MHz):	
USA version	
Receiver	0.030000 ~ 199.999999*
	400.000000 ~ 470.000000*
Transmitter	1.800000 ~ 1.999999
	3.500000 ~ 3.999999
	5.255000 ~ 5.405000
	7.000000 ~ 7.300000
	10.100000 ~ 10.150000
	14.000000 ~ 14.350000
	18.068000 ~ 18.168000
	21.000000 ~ 21.450000
	24.890000 ~ 24.990000
	28.000000 ~ 29.700000
	50.000000 ~ 54.000000
	144.000000 ~ 148.000000
	430.000000 ~ 450.000000
EUR version	
Receiver	0.030000 ~ 199.999999*
	400.000000 ~ 470.000000*
Transmitter	1.810000 ~ 1.999999
	3.500000 ~ 3.800000
	7.000000 ~ 7.200000
	10.100000 ~ 10.150000
	14.000000 ~ 14.350000
	18.068000 ~ 18.168000
	21.000000 ~ 21.450000
	24.890000 ~ 24.990000
	28.000000 ~ 29.700000
	50.000000 ~ 52.000000
	144.000000 ~ 146.000000
	430.000000 ~ 440.000000

\* Some frequency ranges are not guaranteed.

- Operating modes:
  - USB/LSB (J3E), CW (A1A), RTTY (F1B), AM (A3E), FM/WFM\* (F2D/F3E), and DV (F7W)
  - \* WFM: RX only
- Number of memory channels:
  - 500 channels (in 100 groups)
- Number of program scan channels:
  - 25 channels
  - (2 edge frequencies in each channel)
- Number of call channels:
  - 4 channels (2 channels × 2 bands)
- Number of repeater memories: 2500
- Number of GPS memories: 300
- Antenna impedance: 50 Ω unbalanced
- Antenna connector: BNC (50 Ω)
- Power supply requirement:
  - 13.8 V DC (±15%) for external DC power
  - 7.4 V DC specified Icom's battery pack

- Operating temperature range:
  - 10°C ~ +60°C, 14°F ~ 140°F
- Frequency stability:
  - Less than ±0.5 ppm
  - (-10°C ~ +60°C, 14°F ~ 140°F)
- Frequency resolution: 1 Hz (minimum)
- Power consumption:
  - Using external DC power (13.8 V DC)
    - Receive
      - Standby 0.3 A (typical)
      - Maximum audio 0.5 A (typical)
    - Transmit
      - Maximum power (10 W) 3.0 A
  - Using specified Icom's battery pack (7.4 V DC)
    - Receive
      - Standby 0.5 A (typical)
      - Maximum audio 0.8 A (typical)
    - Transmit
      - Maximum power (5 W) 2.5 A
- Dimensions (projections not included):
  - 200.0 (W) × 83.5 (H) × 82.0 (D) mm,
  - 7.9 (W) × 3.3 (H) × 3.2 (D) in
- Weight (approximate): 1.1 kg, 2.4 lb

## ◇ Transmitter

- Transmit output power:
  - Using external DC power (13.8 V DC)
    - SSB, CW, FM, RTTY, DV 0.1 ~ 10 W
    - AM 0.025 ~ 2.5 W
  - Using specified Icom's battery pack (7.4 V DC)
    - SSB, CW, FM, RTTY, DV 0.1 ~ 5 W
    - AM 0.025 ~ 1.25 W
- SAR 10g: 0.643 W/kg
- Modulation system:
 

SSB	Digital PSN modulation
FM	Digital Reactance modulation
AM	Digital Low power modulation
DV	Digital GMSK modulation
- Spurious emission:
 

Harmonics	
1.8 ~ 28 MHz band	Less than -50 dB
50 MHz band	Less than -60 dB
144/430 MHz band	Less than -60 dB
Out-of-band emission	
1.8 ~ 28 MHz band	Less than -40 dB
50 MHz band	Less than -60 dB
144/430 MHz band	Less than -60 dB
- Carrier suppression: More than 50 dB
- Unwanted sideband suppression:
  - More than 50 dB
- Microphone impedance: 2.2 kΩ

## ◇ Receiver

- Receive system:
  - 0.03 ~ 24.999999 MHz RF Direct Sampling
  - 25 ~ 199.999999 MHz, 400 ~ 470 MHz Down Conversion IF Sampling
- Intermediate frequency:
  - 25 ~ 199.999999 MHz, 400 ~ 470 MHz
  - 38.85 MHz ±0.5 MHz
- Sensitivity:
  - SSB/CW  
(SSB: BW=2.4 kHz, Filter: SOFT, 10 dB S/N  
CW: BW=500 Hz, Filter: SHARP, 10 dB S/N)
  - 1.8 ~ 29.999999 MHz
    - Less than -14 dBμV (0.20 μV) \*1
    - 50 MHz band Less than -16 dBμV (0.15 μV) \*2
    - 144/430 MHz band Less than -19 dBμV (0.11 μV) \*3
  - AM (BW=6 kHz, 10 dB S/N)
    - 0.5 ~ 1.799999 MHz Less than 22 dBμV (13.0 μV) \*1
    - 1.8 ~ 29.999999 MHz
      - Less than 6 dBμV (2.0 μV) \*1
      - 50 MHz band Less than 0 dBμV (1.0 μV) \*2
      - 108.0 ~ 137.0 MHz Less than 0 dBμV (1.0 μV) \*3
      - 144/430 MHz band Less than 0 dBμV (1.0 μV) \*3
  - FM (at 12 dB SINAD)
    - 28.0 ~ 29.7 MHz Less than -6 dBμV (0.5 μV) \*1
    - 50 MHz band Less than -12 dBμV (0.25 μV) \*2
    - 144/430 MHz band Less than -15 dBμV (0.18 μV) \*3
  - WFM (at 12 dB SINAD)
    - 76.0 ~ 108 MHz Less than -3 dBμV (0.71 μV) \*3
  - DV (1% BER (PN9))
    - 28.0 ~ 29.7 MHz Less than 0 dBμV (1.0 μV) \*1
    - 50 MHz band Less than -4 dBμV (0.63 μV) \*2
    - 144/430 MHz band Less than -9 dBμV (0.35 μV) \*3

\*1 Preamp 1 is ON, \*2 Preamp 2 is ON, \*3 Preamp is ON
- Sensitivity for the European version:
  - SSB/CW (BW=2.4 kHz, 12 dB SINAD)
    - 1.8 ~ 2.999999 MHz Less than 10 dBμV emf \*1
    - 3.0 ~ 29.999999 MHz Less than 0 dBμV emf \*1
    - 50 MHz band Less than -6 dBμV emf \*2
    - 144/430 MHz band Less than -6 dBμV emf \*3
  - AM (BW=4 kHz, 60% Modulation, 12 dB SINAD)
    - 1.8 ~ 2.999999 MHz Less than 16 dBμV emf \*1
    - 3.0 ~ 29.999999 MHz Less than 6 dBμV emf \*1
    - 50 MHz band Less than 0 dBμV emf \*2
    - 144/430 MHz band Less than 0 dBμV emf \*3
  - FM (BW=7 kHz, 60% Modulation, 12 dB SINAD)
    - 28.0 ~ 29.7 MHz Less than 0 dBμV emf \*1
    - 50 MHz band Less than -6 dBμV emf \*2
    - 144/430 MHz band Less than -6 dBμV emf \*3

\*1 Preamp 1 is ON, \*2 Preamp 2 is ON, \*3 Preamp is ON
- Selectivity (Filter: SHARP):
  - SSB (BW=2.4 kHz) More than 2.4 kHz/-6 dB  
Less than 3.4 kHz/-40 dB
  - CW (BW=500 Hz) More than 500 Hz/-6 dB  
Less than 700 Hz/-40 dB
  - RTTY (BW=500 Hz) More than 500 Hz/-6 dB  
Less than 800 Hz/-40 dB
  - AM (BW=6 kHz) More than 6.0 kHz/-6 dB  
Less than 10 kHz/-40 dB
  - FM (BW=15 kHz) More than 12.0 kHz/-6 dB  
Less than 22 kHz/-40 dB
  - DV (Channel spacing=12.5 kHz)  
More than -50 dB
- Spurious and image rejection:
  - SSB/CW/AM/FM
    - HF band More than 70 dB\*  
(except for ADC aliasing)
    - 50 MHz band More than 70 dB\*
    - 144 MHz band More than 65 dB
    - 430 MHz band More than 54 dB
  - \* At Intermediate frequency in 25 ~ 30 MHz  
or 50 ~ 54 MHz: More than 50 dB
- Audio output power:
  - Internal speaker More than 0.53 W (12 Ω load,  
1 kHz, 10% distortion)
  - External speaker More than 0.2 W (8 Ω load,  
1 kHz, 10% distortion)
- AF output impedance:
  - 8 Ω
- RIT variable range: ±9.999 kHz
- ANF attenuation: More than 30 dB  
(with 1 kHz single tone)
- MNF attenuation: More than 70 dB
- NR attenuation: More than 6 dB  
(noise rejection in SSB)

### ◇ Wireless LAN

- Wireless LAN standard: IEEE802.11 b/g/n
- Authentication and Encryption: WEP (64/128 bit), WPA-PSK (TKIP), WPA2-PSK (AES)
- Channels: 1 to 13 (2.4 GHz band)  
① May differ depending on the country of use.
- Protocol: TCP/IP
- Output power: Less than 10 mW/MHz

### ◇ Bluetooth

- Version: Bluetooth Version 4.2
- Transmission Output: Class 2
- Profile: HFP, HSP, SPP, GATT (Serial) over LE
- The maximum number of paired Bluetooth devices: 5 devices  
① Either headsets or data devices are maximum 4 devices, and the combination is 5 devices in total.
- Device Name: ICOM BT(IC-705) (default value)
- Passkey: 0000 (four zeros)

① All stated specifications are typical and subject to change without notice or obligation.

# 12 OPTIONS

## Options

(As of October 2020)

### Speaker microphone

#### HM-243 SPEAKER MICROPHONE

The same as supplied.

### Batteries/Charger

#### BP-272 Li-ion BATTERY PACK

The same as supplied.

Voltage: 7.4 V

Discharge capacity: 1880 mAh (minimum),  
2000 mAh (typical)

#### BP-307 Li-ion BATTERY PACK

Voltage: 7.2 V

Discharge capacity: 3050 mAh (minimum),  
3150 mAh (typical)

#### BC-202IP2 RAPID CHARGER

### Software

#### RS-BA1 Version 2 IP REMOTE CONTROL SOFTWARE

**NOTE:** To remotely control transceivers using the RS-BA1 software, BE SURE to comply with your local regulations.

### Cables

#### OPC-2421 DC POWER CABLE

The same as supplied.

#### CP-22 CIGARETTE LIGHTER CABLE

For BC-202IP2, 12 V/24 V

① You cannot connect to the IC-705's [DC 13.8 V] jack.

#### CP-23L CIGARETTE LIGHTER CABLE

For BC-202IP2, 12 V

① You cannot connect to the IC-705's [DC 13.8 V] jack.

#### OPC-2417 DATA CABLE (USB micro-B/USB micro-B)

#### OPC-2418 DATA CABLE (USB micro-B/USB Type-C)

### Others

#### VS-3 Bluetooth® HEADSET

#### LC-192 MULTI-BAG

#### MBF-705 DESKTOP STAND

An external antenna tuner for the IC-705 is coming soon.

### About the free download software

CS-705	PROGRAMMING SOFTWARE
RS-MS1A (For Android™ devices)	Android™ APPLICATION
RS-MS3A (For Android™ devices)	TERMINAL MODE/ACCESS POINT MODE SOFTWARE
RS-MS3W (For Windows)	TERMINAL MODE/ACCESS POINT MODE SOFTWARE
ST-4001A (For Android™ devices)	PICTURE UTILITY SOFTWARE
ST-4001I (For iOS™ devices)	PICTURE UTILITY SOFTWARE
ST-4001W (For Windows)	PICTURE UTILITY SOFTWARE

You can download each manual and guide from the Icom website.

<https://www.icomjapan.com/support/>

Before using, read each manual and guide, and use it according to the instructions.

① To add or expand a function, or to improve the performance, the software version may be upgraded.

Before you update your software version, see the instructions and cautions described on the Icom website.

## [DC 13.8 V]

Accepts regulated DC power of 13.8 V DC  $\pm 15\%$  through the supplied DC power cable.

① The maximum transmit power depends on the power source.

- When using an external DC power supply (13.8 V DC): 10 W
- When using the battery pack: 5 W

### ⚠ WARNING!

- **NEVER** reverse the DC power cable polarity.
- **NEVER** remove the fuse holder on the DC power cable.
- **NEVER** use other than specified DC power cable.
- **NEVER** modify, bend by force, twist, pull or heat the DC power cable.
- **NEVER** put something heavy on the DC power cable.

## Connecting an external DC power supply

Confirm that the transceiver is OFF before connecting the DC power cable.

① When connecting a DC power cable, the transceiver needs:

- DC 13.8 V (Capacity: At least 5 Amps)
- A power supply with an over current protective line, and low voltage fluctuation or ripple.

① To charge the battery pack while the transceiver is ON, set the following item to "ON" (default).

**MENU** » **SET > Function > Charging (Power ON)**

① You cannot connect the optional cigarette lighter cable (CP-22 and CP-23L) to the IC-705's [DC 13.8 V] jack.

### Non-Icom DC power supply

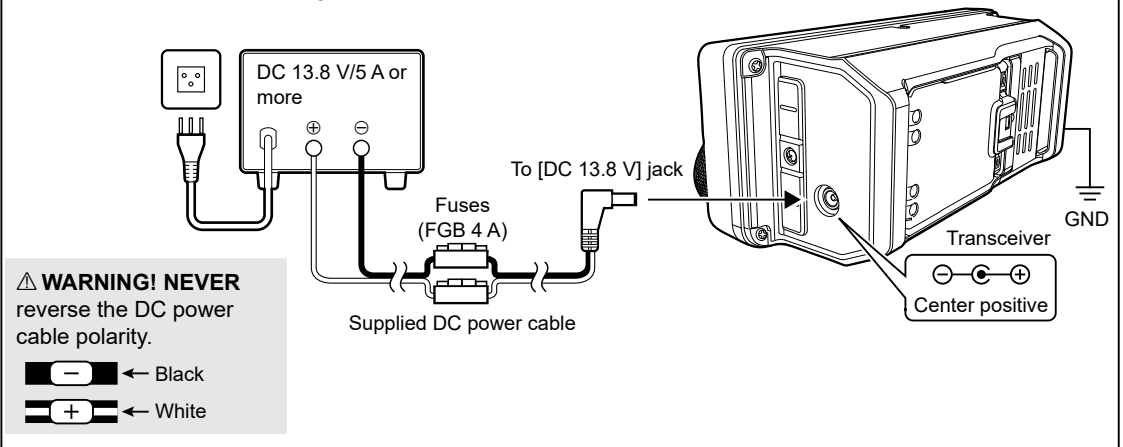

## Grounding

When connecting an external DC power source, ground the transceiver using the ground terminal [GND] on the side panel to prevent electrical shock, television interference (TVI), broadcast interference (BCI), and other problems.

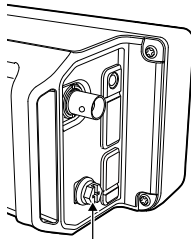

For best results, connect a heavy gauge wire or strap to a long ground rod. Make the distance between the [GND] terminal and ground as short as possible.

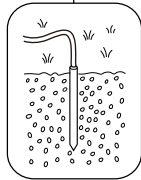

**⚠ WARNING! NEVER** connect the [GND] terminal to a gas or electric pipe, since the connection could cause an explosion or electric shock.

## [SEND/ALC]

### ① ALC

When operating with a non-Icom linear amplifier, input ALC voltage (-4 ~ 0 V) from the linear amplifier.

### ② SEND

To control an external device such as a non-Icom linear amplifier, the terminal goes low when the transceiver transmits.

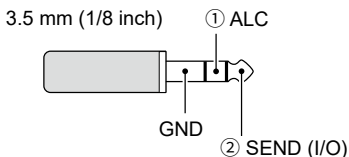

## [KEY]

Connect a Paddle key or Straight key.

① You can select the key type.

**MENU** » **KEYER > EDIT/SET**  
**> CW-KEY SET > Key Type**

### • Paddle key

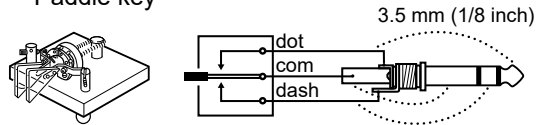

### • Straight key

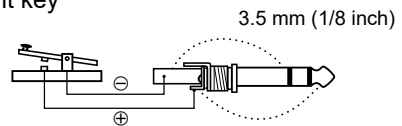

By connecting an external keypad to [KEY] with a circuit as shown below, you can send memory content from one of the 8 memories. You can send memory content from a CW Keyer Memory (M1 ~ M8), SSB/AM/FM/DV Voice Memory (T1 ~ T8), or RTTY Memory (RT1 ~ RT8) to be transmitted.

- Push a switch to send memory content.
- Hold down the switch for 1 second to repeatedly send memory content.

① To use the external keypad, turn ON the following item.

**MENU** » **SET > Connectors > External Keypad**

① The external keypad shown below is not supplied by Icom.

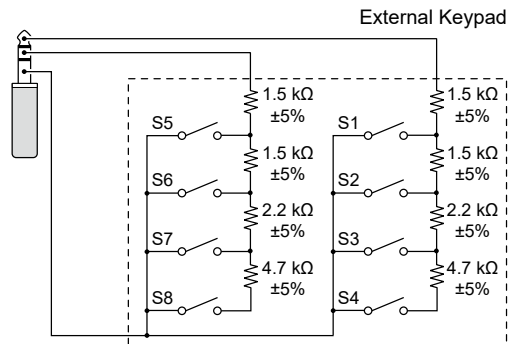

**TIP:** You can alternate between an external keypad and a Paddle key or Straight key, when connecting them in parallel.



**[microUSB]**

Use the microUSB (1.1/2.0) type B port for:

- Charging the attached battery pack.
- Outputting decoded RTTY data.
- Outputting a demodulated AF signal or 12 kHz IF signal.
- Inputting a modulation AF signal.
- Inputting weather data for weather station transmission.
- Interface for remote control using CI-V commands.
- Cloning setting data using the CS-705 software.
- Remotely control using optional RS-BA1.
- Using the External Gateway function.

① You can change the signal output type and output level.

① You can download the USB driver and installation guide from the Icom website.  
<https://www.icomjapan.com/support/>

**[ANT]**

Connect an antenna. (BNC)

- Input/Output impedance: 50  $\Omega$  (unbalanced)

**NOTE:** If the transceiver receives noise from itself, keeping the antenna away from the transceiver may reduce the noise.

**[SP]**

Connect a microphone, standard stereo headphones, or external speaker.

The output impedance and output level differ, depending on the amplifier that is used.

① You can change the amplifier that is used.

Set the following item according to the connected device.

**MENU** » **SET > Connectors > SP Jack Function**

When using the amplifier for a speaker:

- Output impedance: 8  $\Omega$
- Output level: More than 0.2 W  
(8  $\Omega$  load, 10% distortion)

When using the amplifier for a headset:

- Output impedance: 10  $\Omega$
- Output level: More than 5 mW  
(16  $\Omega$  load, 10% distortion)

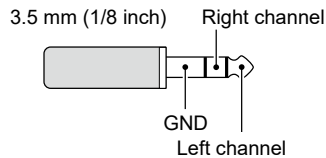
**[MIC]**

Connect a microphone.

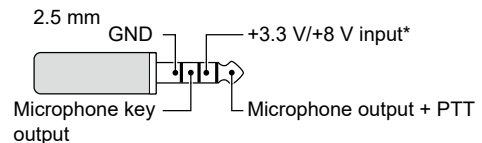

\* You can select from +3.3 V (through 470  $\Omega$ ) and +8.0 V (Maximum 10 mA)

**MENU** » **SET > Connectors > MIC Jack 8V Output**

① Confirm that the transceiver is OFF before connecting or disconnecting optional equipment.

---

# INSTALLATION NOTES

For amateur base station installations it is recommended that the forward clearance in front of the antenna array is calculated relative to the EIRP (Effective Isotropic Radiated Power). The clearance height below the antenna array can be determined in most cases from the RF power at the antenna input terminals.

As different exposure limits have been recommended for different frequencies, a relative table shows a guideline for installation considerations.

Below 30 MHz, the recommended limits are specified in terms of V/m or A/m fields as they are likely to fall within the near-field region. Similarly, the antennas may be physically short in terms of electrical length and that the installation will require some antenna matching device which can create local, high intensity magnetic fields. Analysis of such MF installations is best considered in association with published guidance notes such as the FCC OET Bulletin 65 Edition 97-01 and its annexes relative to amateur transmitter installations. The EC recommended limits are almost identical to the FCC specified 'uncontrolled' limits and tables exist that show pre-calculated safe distances for different antenna types for different frequency bands. Further information can be found at <http://www.arrl.org/>.

### • Typical amateur radio installation

Exposure distance assumes that the predominant radiation pattern is forward and that radiation vertically downwards is at unity gain (sidelobe suppression is equal to main lobe gain). This is true of almost every gain antenna today.

Exposed persons are assumed to be beneath the antenna array and have a typical height of 1.8 m.

The figures assume the worst case emission of a constant carrier.

For the bands 10 MHz and higher the following power density limits have been recommended:

10–50 MHz 2 W/sq m

### Vertical clearance by EIRP output

1 Watts	2.1 m
10 Watts	2.8 m
25 Watts	3.4 m
100 Watts	5 m
1000 Watts	12 m

### Forward clearance by EIRP output

100 Watts	2 m
1000 Watts	6.5 m
10,000 Watts	20 m
100,000 Watts	65 m

In all cases any possible risk depends on the transmitter being activated for long periods. (actual recommendation limits are specified as an average during 6 minutes)

Normally the transmitter is not active for long periods of time. Some radio licenses will require that a timer circuit automatically cuts the transmitter after 1–2 minutes etc.

Similarly some types of emission, i.e., SSB, CW, AM etc. have a lower 'average' output power and the assessed risk is even lower.



Your Icom radio generates RF electromagnetic energy while transmitting. This radio is designed for and classified as for “Occupational Use Only.” This means it must be used only during the course of

employment by individuals aware of the hazards, and the ways to minimize such hazards. This radio is NOT intended for use by the “General Population” in an uncontrolled environment. This radio has been tested and complies with the FCC and IC RF exposure limits for “Occupational Use Only”. In addition, your Icom radio complies with the following Standards and Guidelines with regard to RF energy and electromagnetic energy levels and evaluation of such levels for exposure to humans:

- FCC KDB Publication 447498 D03, Evaluating Compliance with FCC Guidelines for Human Exposure to Radio Frequency Electromagnetic Fields.
- American National Standards Institute (C95.1-2010), IEEE Standard for Safety Levels with Respect to Human Exposure to Radio Frequency Electromagnetic Fields, 3 kHz to 300 GHz.
- American National Standards Institute (C95.3-2002), IEEE Recommended Practice for the Measurement of Potentially Hazardous Electromagnetic Fields– RF and Microwave.
- The accessories listed on page 12-1 are authorized for use with this product. Use of accessories other than those specified may result in RF exposure levels exceeding the FCC requirements for wireless RF exposure.
- Health Canada Safety Code 6 - Limits of Human Exposure to Electromagnetic Energy in the Frequency Range from 3 kHz to 300 GHz.



To ensure that your exposure to RF electromagnetic energy is within the FCC allowable limits for occupational use, always adhere to the following guidelines:

- **DO NOT** operate the radio without a proper antenna attached, as this may damage the radio and may also cause you to exceed FCC RF exposure limits. A proper antenna is an antenna specifically authorized by the manufacturer for use with this radio.
- **DO NOT** transmit for more than 50% of the total radio use time (“50% duty cycle”). Transmitting more than 50% of the time can cause FCC RF exposure compliance requirements to be exceeded. The radio is transmitting when the TX/RX indicator lights red. You can cause the radio to transmit by pushing the [PTT] switch or the VOX function.
- **ALWAYS** keep the antenna at least 2.5 cm (1 inch) away from the body when transmitting, and only use the LC-192 MULTI-BAG when attaching the radio to your body, to ensure FCC and IC RF exposure compliance requirements are not exceeded.

The information listed above provides the user with the information needed to make him or her aware of RF exposure, and what to do to assure that this radio operates within the FCC RF exposure limits of this radio.

### Electromagnetic Interference/Compatibility

During transmissions, your Icom radio generates RF energy that can possibly cause interference with other devices or systems. To avoid such interference, turn off the radio in areas where signs are posted to do so. **DO NOT** operate the transmitter in areas that are sensitive to electromagnetic radiation such as hospitals and blasting sites.

### Occupational/Controlled Use

The radio transmitter is used in situations in which persons are exposed as consequence of their employment provided those persons are fully aware of the potential for exposure and can exercise control over their exposure.

## ABOUT THE LICENSES

Information on the open source software being used by this product.

### COPYRIGHT NOTICE, DISCLAIMER, and LICENSE:

If you modify libpng you may insert additional notices immediately following this sentence.

This code is released under the libpng license.

libpng versions 1.2.6, August 15, 2004, through 1.6.12, June 12, 2014, are Copyright (c) 2004, 2006-2014 Glenn Randers-Pehrson, and are distributed according to the same disclaimer and license as libpng-1.2.5 with the following individual added to the list of Contributing Authors:

Cosmin Truta

libpng versions 1.0.7, July 1, 2000, through 1.2.5, October 3, 2002, are Copyright (c) 2000-2002 Glenn Randers-Pehrson, and are distributed according to the same disclaimer and license as libpng-1.0.6 with the following individuals added to the list of Contributing Authors:

Simon-Pierre Cadieux  
Eric S. Raymond  
Gilles Vollant

and with the following additions to the disclaimer:

There is no warranty against interference with your enjoyment of the library or against infringement. There is no warranty that our efforts or the library will fulfill any of your particular purposes or needs. This library is provided with all faults, and the entire risk of satisfactory quality, performance, accuracy, and effort is with the user.

libpng versions 0.97, January 1998, through 1.0.6, March 20, 2000, are Copyright (c) 1998, 1999, 2000 Glenn Randers-Pehrson, and are distributed according to the same disclaimer and license as libpng-0.96, with the following individuals added to the list of Contributing Authors:

Tom Lane  
Glenn Randers-Pehrson  
Willem van Schaik

libpng versions 0.89, June 1996, through 0.96, May 1997, are Copyright (c) 1996, 1997 Andreas Dilger Distributed according to the same disclaimer and license as libpng-0.88, with the following individuals added to the list of Contributing Authors:

John Bowler  
Kevin Bracey  
Sam Bushell  
Magnus Holmgren  
Greg Roelofs  
Tom Tanner

libpng versions 0.5, May 1995, through 0.88, January 1996, are Copyright (c) 1995, 1996 Guy Eric Schalnat, Group 42, Inc.

For the purposes of this copyright and license, "Contributing Authors" is defined as the following set of individuals:

Andreas Dilger  
Dave Martindale  
Guy Eric Schalnat  
Paul Schmidt  
Tim Wegner

The PNG Reference Library is supplied "AS IS". The Contributing Authors and Group 42, Inc. disclaim all warranties, expressed or implied, including, without limitation, the warranties of merchantability and of

fitness for any purpose. The Contributing Authors and Group 42, Inc. assume no liability for direct, indirect, incidental, special, exemplary, or consequential damages, which may result from the use of the PNG Reference Library, even if advised of the possibility of such damage.

Permission is hereby granted to use, copy, modify, and distribute this source code, or portions hereof, for any purpose, without fee, subject to the following restrictions:

1. The origin of this source code must not be misrepresented.
2. Altered versions must be plainly marked as such and must not be misrepresented as being the original source.
3. This Copyright notice may not be removed or altered from any source or altered source distribution.

The Contributing Authors and Group 42, Inc. specifically permit, without fee, and encourage the use of this source code as a component to supporting the PNG file format in commercial products. If you use this source code in a product, acknowledgment is not required but would be appreciated.

A "png\_get\_copyright" function is available, for convenient use in "about" boxes and the like:

```
printf("%s", png_get_copyright(NULL));
```

Also, the PNG logo (in PNG format, of course) is supplied in the files "pngbar.png" and "pngbar.jpg" (88x31) and "pngnow.png" (98x31).

Libpng is OSI Certified Open Source Software. OSI Certified is a certification mark of the Open Source Initiative.

The contributing authors would like to thank all those who helped with testing, bug fixes, and patience. This wouldn't have been possible without all of you.

Thanks to Frank J. T. Wojcik for helping with the documentation.

License for CMSIS-RTOS RTX Implementation  
Copyright (c) 1999-2009 KEIL, 2009-2013 ARM  
Germany GmbH All rights reserved.

Redistribution and use in source and binary forms, with or without modification, are permitted provided that the following conditions are met:

- Redistributions of source code must retain the above copyright notice, this list of conditions and the following disclaimer.
- Redistributions in binary form must reproduce the above copyright notice, this list of conditions and the following disclaimer in the documentation and/or other materials provided with the distribution.
- Neither the name of ARM nor the names of its contributors may be used to endorse or promote products derived from this software without specific prior written permission.

THIS SOFTWARE IS PROVIDED BY THE COPYRIGHT HOLDERS AND CONTRIBUTORS "AS IS" AND ANY EXPRESS OR IMPLIED WARRANTIES, INCLUDING, BUT NOT LIMITED TO, THE IMPLIED WARRANTIES OF MERCHANTABILITY AND FITNESS

FOR A PARTICULAR PURPOSE ARE DISCLAIMED. IN NO EVENT SHALL COPYRIGHT HOLDERS AND CONTRIBUTORS BE LIABLE FOR ANY DIRECT, INDIRECT, INCIDENTAL, SPECIAL, EXEMPLARY, OR CONSEQUENTIAL DAMAGES (INCLUDING, BUT NOT LIMITED TO, PROCUREMENT OF SUBSTITUTE GOODS OR SERVICES; LOSS OF USE, DATA, OR PROFITS; OR BUSINESS INTERRUPTION) HOWEVER CAUSED AND ON ANY THEORY OF LIABILITY, WHETHER IN CONTRACT, STRICT LIABILITY, OR TORT (INCLUDING NEGLIGENCE OR OTHERWISE) ARISING IN ANY WAY OUT OF THE USE OF THIS SOFTWARE, EVEN IF ADVISED OF THE POSSIBILITY OF SUCH DAMAGE.

## ZLIB DATA COMPRESSION LIBRARY

zlib 1.2.8 is a general purpose data compression library. All the code is thread safe. The data format used by the zlib library is described by RFCs (Request for Comments) 1950 to 1952 in the files <http://tools.ietf.org/html/rfc1950> (zlib format), [rfc1951](http://tools.ietf.org/html/rfc1951) (deflate format) and [rfc1952](http://tools.ietf.org/html/rfc1952) (gzip format).

All functions of the compression library are documented in the file `zlib.h` (volunteer to write man pages welcome, contact [zlib@gzip.org](mailto:zlib@gzip.org)). A usage example of the library is given in the file `test/example.c` which also tests that the library is working correctly. Another example is given in the file `test/minigzip.c`. The compression library itself is composed of all source files in the root directory.

To compile all files and run the test program, follow the instructions given at the top of `Makefile.in`. In short `./configure; make test`, and if that goes well, `make install` should work for most flavors of Unix. For Windows, use one of the special makefiles in `win32/` or `contrib/vstudio/`. For VMS, use `make_vms.com`.

Questions about zlib should be sent to [zlib@gzip.org](mailto:zlib@gzip.org), or to Gilles Vollant [info@winimage.com](mailto:info@winimage.com) for the Windows DLL version. The zlib home page is <http://zlib.net/>. Before reporting a problem, please check this site to verify that you have the latest version of zlib; otherwise get the latest version and check whether the problem still exists or not.

PLEASE read the zlib FAQ [http://zlib.net/zlib\\_faq.html](http://zlib.net/zlib_faq.html) before asking for help.

Mark Nelson [markn@ieee.org](mailto:markn@ieee.org) wrote an article about zlib for the Jan. 1997 issue of Dr. Dobbs's Journal; a copy of the article is available at <http://marknelson.us/1997/01/01/zlib-engine/>.

The changes made in version 1.2.8 are documented in the file `ChangeLog`.

Unsupported third party contributions are provided in directory `contrib/`.

zlib is available in Java using the `java.util.zip` package, documented at <http://java.sun.com/developer/technicalArticles/Programming/compression/>.

A Perl interface to zlib written by Paul Marquess [pmqs@cpan.org](mailto:pmqs@cpan.org) is available at CPAN (Comprehensive Perl Archive Network) sites, including <http://search.cpan.org/~pmqs/IO-Compress-Zlib/>.

A Python interface to zlib written by A.M.Kuchling [amk@amk.ca](mailto:amk@amk.ca) is available in Python 1.5 and later versions, see <http://docs.python.org/library/zlib.html>.

zlib is built into tcl: <http://wiki.tcl.tk/4610>.

An experimental package to read and write files in `.zip`

format, written on top of zlib by Gilles Vollant [info@winimage.com](mailto:info@winimage.com), is available in the `contrib/minizip` directory of zlib.

Notes for some targets:

- For Windows DLL versions, please see `win32/DLL_FAQ.txt`
- For 64-bit Irix, `deflate.c` must be compiled without any optimization. With `-O`, one `libpng` test fails. The test works in 32 bit mode (with the `-n32` compiler flag). The compiler bug has been reported to SGI.
- zlib doesn't work with gcc 2.6.3 on a DEC 3000/300LX under OSF/1 2.1 it works when compiled with `cc`.
- On Digital Unix 4.0D (formerly OSF/1) on AlphaServer, the `cc` option `-std1` is necessary to get `gzprintf` working correctly. This is done by `configure`.
- zlib doesn't work on HP-UX 9.05 with some versions of `/bin/cc`. It works with other compilers. Use `"make test"` to check your compiler.
- `gzdopen` is not supported on RISCOS or BEOS.
- For PalmOs, see <http://palmzlib.sourceforge.net/>

## Acknowledgments:

The deflate format used by zlib was defined by Phil Katz. The deflate and zlib specifications were written by L. Peter Deutsch. Thanks to all the people who reported problems and suggested various improvements in zlib; they are too numerous to cite here.

## Copyright notice:

(C) 1995-2013 Jean-loup Gailly and Mark Adler

This software is provided 'as-is', without any express or implied warranty. In no event will the authors be held liable for any damages arising from the use of this software.

Permission is granted to anyone to use this software for any purpose, including commercial applications, and to alter it and redistribute it freely, subject to the following restrictions:

1. The origin of this software must not be misrepresented; you must not claim that you wrote the original software. If you use this software in a product, an acknowledgment in the product documentation would be appreciated but is not required.
2. Altered source versions must be plainly marked as such, and must not be misrepresented as being the original software.
3. This notice may not be removed or altered from any source distribution.

Jean-loup Gailly Mark Adler

[jloup@gzip.org](mailto:jloup@gzip.org) [madler@alumni.caltech.edu](mailto:madler@alumni.caltech.edu)

If you use the zlib library in a product, we would appreciate \*not\* receiving lengthy legal documents to sign. The sources are provided for free but without warranty of any kind. The library has been entirely written by Jean-loup Gailly and Mark Adler; it does not include third-party code.

If you redistribute modified sources, we would appreciate that you include in the file `ChangeLog` history information documenting your changes. Please read the FAQ for more information on the distribution of modified source versions.

# INDEX

1/4 Tuning function .....	3-3	Microphone gain .....	3-10
	<b>A</b>	Microphone plate .....	1-1
AGC function .....	4-3	microSD card .....	6-1
All reset .....	10-2	Monitor function .....	4-2
Attenuator .....	4-1	Multi-function	
Audio scope .....	5-3	Dial .....	2-8
Auto Tuning Step function .....	3-3	Menus .....	2-7
	<b>B</b>	My Station (Set mode) .....	8-8
Band Edge .....	3-5		<b>N</b>
Band Edge Beep .....	3-5, 8-2	Noise Blanker .....	4-7
Band Stacking Register .....	3-2	Noise Reduction .....	4-8
Battery icon .....	1-2	Noise squelch .....	3-8
Battery pack		NTP Function .....	8-18
Attaching .....	1-1		<b>O</b>
Charging .....	1-2	Operating band .....	3-2
Bluetooth Set (Set mode) .....	8-18	Operating mode .....	3-2
Break-in function .....	4-12	Options .....	12-1
	<b>C</b>	Oscilloscope .....	5-3
Call channel mode .....	3-1	Others (Set mode) .....	8-23
Cleaning .....	10-1		<b>P</b>
Clock		Panel	
Current time .....	9-1	Bottom .....	2-2
Date .....	9-1	Front .....	2-1
UTC offset .....	9-1	Side .....	2-3
Connecting		Touch screen .....	2-4
DC power supply .....	13-1	Partial reset .....	10-2
Connectors (Set mode) .....	8-13	Power ON or OFF .....	3-1
CW		Power Save .....	8-3
Pitch control .....	4-11	Preamplifiers .....	4-1
Side tone .....	4-12		<b>Q</b>
	<b>D</b>	QSO/RX Log (Set mode) .....	8-10
Data mode .....	3-2	QUICK MENU .....	2-7
Dial Lock function .....	3-8	Quick Split function .....	4-10, 8-4
Digital Twin PBT .....	4-4		<b>R</b>
Display .....	2-4	Resetting .....	10-1
Display (Set mode) .....	8-15	RF gain .....	3-8
DV Set (Set mode) .....	8-8	RIT function .....	4-2
	<b>E</b>		<b>S</b>
Electronic Keyer function .....	4-13	SD card .....	6-1
Entering and editing .....	v	SD Card (Set mode) .....	8-22
	<b>F</b>	S-meter squelch .....	3-8
Filter		Spectrum scope	
IF filter .....	4-5	Center mode .....	5-2
Notch Filter .....	4-6	Fixed mode .....	5-2
Transmit filter width .....	4-8	Marker .....	5-1
Fine Tuning function .....	3-3	Mini scope screen .....	5-2
Frequency		Speech Compressor .....	4-9
Directly entering .....	3-4	Split frequency operation .....	4-10
Using the Main Dial .....	3-3	Split Lock function .....	4-11, 8-4
Function (Set mode) .....	8-2	SQL level .....	3-8
Fuse .....	10-1	Squelch .....	3-8
	<b>G</b>		<b>T</b>
GPS .....	7-1	Time Set (Set mode) .....	8-18
Grounding .....	13-2	Tone Control/TBW (Set mode) .....	8-2
	<b>K</b>	transmit output power .....	3-9
Keyboard		Troubleshooting .....	10-3
Entering and editing .....	v	Tuning Step function .....	3-3
Keyboard Type .....	v, 8-6		<b>V</b>
	<b>M</b>	VFO mode .....	3-1
MAX TX PWR .....	3-10	Volume level .....	3-1
Memory mode .....	3-1		<b>W</b>
MENU screen .....	2-7	Weather channel mode .....	3-1
Meter .....	3-9	WLAN Set (Set mode) .....	8-20



**Count on us!**