



INSTRUCTION MANUAL

VHF MARINE TRANSCEIVER
IC-M323
IC-M323G
IC-M324
IC-M324G

This device complies with Part 15 of the FCC Rules. Operation is subject to the condition that this device does not cause harmful interference.



Icom Inc.

FOREWORD

Thank you for choosing this Icom product. The IC-M323/IC-M323G/IC-M324/IC-M324G VHF MARINE TRANSCEIVER is designed and built with Icom's state of the art technology and craftsmanship. With proper care, this product should provide you with years of trouble-free operation.

Hope you agree with Icom's philosophy of "technology first." Many hours of research and development went into the design of your radio.

◇ **FEATURES**

- *Simple operation with large keys*
- *Easy to hear speaker*
- *Built-in DSC meets ITU Class D requirement*
- *Rugged waterproof construction*
- *Easy to make an individual DSC calls using the optional MA-500TR Class B AIS Transponder*
- *Built-in GPS **

*For only IC-M323G and IC-M324G.

Icom, Icom Inc. and the Icom logo are registered trademarks of Icom Incorporated (Japan) in Japan, the United States, the United Kingdom, Germany, France, Spain, Russia, and/or other countries.

IMPORTANT

READ ALL INSTRUCTIONS carefully and completely before using the transceiver.

SAVE THIS INSTRUCTION MANUAL — This instruction manual contains important operating instructions for the transceiver.

EXPLICIT DEFINITIONS

| WORD | DEFINITION |
|-------------------|---|
| ⚠ WARNING! | Personal injury, fire hazard or electric shock may occur. |
| CAUTION | Equipment damage may occur. |
| NOTE | If disregarded, inconvenience only. No risk of personal injury, fire or electric shock. |

CLEAN THE TRANSCEIVER AND MICROPHONE THOROUGHLY WITH FRESH WATER after exposure to water including salt, otherwise, the keys and switch may become inoperable due to salt crystallization.

IN CASE OF EMERGENCY

If your vessel requires assistance, contact other vessels and the Coast Guard by sending a Distress call on Channel 16.

USING CHANNEL 16

DISTRESS CALL PROCEDURE

1. "MAYDAY MAYDAY MAYDAY."
2. "THIS IS" (name of vessel).
3. Say your call sign or other description of the vessel (AND 9 digit DSC ID if you have one).
4. "LOCATED AT" (your position).
5. State the nature of the distress and assistance required.
6. Give any other information which might facilitate the rescue.

Or, make your Distress call using digital selective calling on Channel 70.

USING DIGITAL SELECTIVE CALLING (Ch 70)

DISTRESS CALL PROCEDURE

1. While lifting up the key cover, hold down [DISTRESS] for 3 seconds until you hear 3 short beeps and then one long beep.
2. Wait for an acknowledgment on Channel 70 from a coast station.
 - After the acknowledgement is received, Channel 16 is automatically selected.
3. Hold down [PTT], then transmit the appropriate information as listed above.

INSTALLATION NOTE

Installation:

The installation of this equipment should be made in such a manner as to respect the EC recommended electromagnetic field exposure limits. (1999/519/EC)

The maximum RF power available from this device is 25 watts. The antenna should be installed as high as possible for maximum efficiency and the installation height should be at least 1.4 meters above any accessible position. In the case where an antenna cannot be installed at a reasonable height, then the transmitter should neither be continuously operated for long periods if any person is within a distance of 1.4 meters of the antenna, nor operated at all if any person is touching the antenna.

It is recommended that antenna of a maximum gain of 3 dB are used. If higher gain antenna are required then please contact your Icom distributor for revised installation recommendations.

Operation:

The exposure to RF electromagnetic field is only applicable when this device is transmitting. This exposure is naturally reduced due to the nature of alternating periods of receiving and transmitting. Keep your transmissions to the minimum necessary.

RADIO OPERATOR WARNING



Icom requires the radio operator to meet the FCC Requirements for Radio Frequency Exposure. An omnidirectional antenna with gain not greater than 9 dBi must be mounted a minimum of 5 meters (measured from the lowest point of the antenna) vertically above the main deck and all possible personnel. This is the minimum safe separation distance estimated to meet all RF exposure compliance requirements. This 5 meter distance is based on the FCC Safe Maximum Permissible Exposure (MPE) distance of 3 meters added to the height of an adult (2 meters) and is appropriate for all vessels.

For watercraft without suitable structures, the antenna must be mounted so as to maintain a minimum of 1 meter vertically between the antenna, (measured from the lowest point of the antenna), to the heads of all persons AND all persons must stay outside of the 3 meter MPE radius.

Do not transmit with radio and antenna when persons are within the MPE radius of the antenna, unless such persons (such as driver or radio operator) are shielded from antenna field by a grounded metallic barrier. The MPE Radius is the minimum distance from the antenna axis that person should maintain in order to avoid RF exposure higher than the allowable MPE level set by FCC.

FAILURE TO OBSERVE THESE LIMITS MAY ALLOW THOSE WITHIN THE MPE RADIUS TO EXPERIENCE RF RADIATION ABSORPTION WHICH EXCEEDS THE FCC MAXIMUM PERMISSIBLE EXPOSURE (MPE) LIMIT. IT IS THE RESPONSIBILITY OF THE RADIO OPERATOR TO ENSURE THAT THE MAXIMUM PERMISSIBLE EXPOSURE LIMITS ARE OBSERVED AT ALL TIMES DURING RADIO TRANSMISSION. THE RADIO OPERATOR IS TO ENSURE THAT NO BYSTANDERS COME WITHIN THE RADIUS OF THE MAXIMUM PERMISSIBLE EXPOSURE LIMITS.

Determining MPE Radius

THE MAXIMUM PERMISSIBLE EXPOSURE (MPE) RADIUS HAS BEEN ESTIMATED TO BE A RADIUS OF ABOUT 3M PER OET BULLETIN 65 OF THE FCC. THIS ESTIMATE IS MADE ASSUMING THE MAXIMUM POWER OF THE RADIO AND ANTENNAS WITH A MAXIMUM GAIN OF 9dBi ARE USED FOR A SHIP MOUNTED SYSTEM.

AVERTISSEMENT POUR LES OPÉRATEURS RADIO



AVERTISSEMENT

Icom exige que l'opérateur radio se conforme aux exigences de la FCC en matière d'exposition aux radiofréquences. Une antenne omnidirectionnelle dont le gain ne dépasse pas 9dBi doit être fixée à une distance minimale de 5 mètres (mesurée depuis le point le plus bas de l'antenne) verticalement au-dessus du pont principal et de tout le personnel qui peut s'y trouver. Il s'agit de la distance de sécurité minimale prévue pour satisfaire aux exigences de conformité en matière d'exposition aux RF. Cette distance de 5 mètres est établie en fonction de l'exposition maximale admissible sécuritaire de 3 mètres établie par la FCC, à laquelle on ajoute la hauteur d'un adulte (2 mètres); cette distance convient pour tous les navires.

Dans le cas des embarcations sans structure convenable, l'antenne doit être fixée de façon à maintenir une distance minimale de 1 mètre verticalement entre cette antenne (mesurée depuis son point le plus bas) et la tête de toute personne présente; toutes les personnes présentes doivent se tenir à l'extérieur d'un rayon d'exposition maximale admissible de 3 mètres.

Ne pas émettre à l'aide de la radio et de l'antenne lorsque des personnes se trouvent à l'intérieur du rayon d'exposition maximale admissible de cette antenne, à moins que ces personnes (comme le conducteur ou l'opérateur radio) ne soient protégées du champ de l'antenne par un écran métallique relié à la masse. Le rayon d'exposition maximale admissible équivaut à la distance minimale que cette personne doit maintenir entre elle et l'axe de l'antenne pour éviter une exposition aux RF supérieure au niveau d'exposition maximale admissible fixé par la FCC.

LE NON-RESPECT DE CES LIMITES PEUT CAUSER, POUR LES PERSONNES SITUÉES DANS LE RAYON D'EXPOSITION MAXIMALE ADMISSIBLE, UNE ABSORPTION DE RAYONNEMENT DE RF SUPÉRIEURE À L'EXPOSITION MAXIMALE ADMISSIBLE FIXÉE PAR LA FCC.

L'OPÉRATEUR RADIO EST RESPONSABLE D'ASSURER QUE LES LIMITES D'EXPOSITION MAXIMALE ADMISSIBLE SOIENT RESPECTÉES EN TOUT TEMPS PENDANT LA TRANSMISSION RADIO. L'OPÉRATEUR RADIO DOIT S'ASSURER QU'AUCUNE PERSONNE PRÉSENTE NE SE SITUE À L'INTÉRIEUR DU RAYON D'EXPOSITION MAXIMALE ADMISSIBLE.

Établir le rayon d'exposition maximale admissible ON ESTIME QUE LE RAYON D'EXPOSITION MAXIMALE ADMISSIBLE EST D'ENVIRON 3 M, TEL QUE STIPULÉ DANS LE BULLETIN OET 65 DE LA FCC. CETTE DISTANCE ESTIMÉE TIENT COMPTE D'UN SYSTÈME INSTALLÉ SUR UN NAVIRE UTILISANT LA PUISSANCE MAXIMALE DE LA RADIO ET DES ANTENNES DONT LE GAIN MAXIMAL EST DE 9dBi.

FCC INFORMATION

• **FOR CLASS A UNINTENTIONAL RADIATORS:**

This equipment has been tested and found to comply with the limits for a Class A digital device, pursuant to part 15 of the FCC Rules. These limits are designed to provide reasonable protection against harmful interference when the equipment is operated in a commercial environment. This equipment generates, uses, and can radiate radio frequency energy and, if not installed and used in accordance with the instruction manual, may cause harmful interference to radio communications.

Operation of this equipment in a residential area is likely to cause harmful interference in which case the user will be required to correct the interference at his own expense.

• **POUR LES RAYONNEMENTS NON INTENTIONNELS DE CLASSE A:**

Cet équipement a été testé et reconnu conforme aux limites fixées pour un appareil numérique de classe A, conformément au point 15 de la réglementation FCC. Ces limites sont définies de façon à fournir une protection raisonnable contre le brouillage préjudiciable lorsque cet appareil est utilisé dans un environnement commercial. Cet équipement génère, utilise et peut émettre un rayonnement de fréquence radio. S'il n'a pas été installé conformément aux instructions, il peut par ailleurs créer des interférences perturbant les communications radio.

L'utilisation de cet appareil dans une zone résidentielle peut provoquer un brouillage préjudiciable, auquel cas l'utilisateur sera tenu de corriger la situation à ses frais.

NOTE

A WARNING STICKER is supplied with the U.S.A. version transceiver.

To comply with FCC regulations, this sticker must be affixed in such a location as to be readily seen from the operating controls of the radio as in the diagram below. Make sure the chosen location is clean and dry before applying the sticker.

EXAMPLE



PRECAUTIONS

⚠ WARNING! NEVER connect the transceiver to an AC outlet. This may pose a fire hazard or result in an electric shock.

⚠ WARNING! NEVER connect the transceiver to a power source of more than 16 V DC such as a 24 V DC. This could cause a fire or damage the transceiver.

⚠ WARNING! NEVER reverse the DC power cable polarity when connecting to a power source. This could damage the transceiver.

⚠ WARNING! NEVER cut the DC power cable between the DC plug at the back of the transceiver and fuse holder. If an incorrect connection is made after cutting, the transceiver may be damaged.

CAUTION: NEVER place the transceiver where normal operation of the vessel may be hindered or where it could cause bodily injury.

KEEP the transceiver and microphone at least 1 m away from the vessel's magnetic navigation compass.

DO NOT use or place the transceiver in areas with temperatures below -20°C (-4°F) or above $+60^{\circ}\text{C}$ ($+140^{\circ}\text{F}$) or, in areas subject to direct sunlight, such as the dashboard.

DO NOT use harsh solvents such as benzine or alcohol to clean the transceiver, as they will damage the transceiver's surfaces. If the transceiver becomes dusty or dirty, wipe it clean with a soft, dry cloth.

DO NOT disassemble or modify the transceiver for any reason.

BE CAREFUL! The transceiver rear panel will become hot when operating continuously for long periods of time.

Place the transceiver in a secure place to avoid inadvertent use by children.

BE CAREFUL! The transceiver meets IPX7* requirements for waterproof protection. However, once the transceiver has been dropped, waterproof protection cannot be guaranteed because of possible damage to the transceiver's case or the waterproof seal.

* Except for the DC power connector, NMEA In/Out leads and AF Out leads.

For U.S.A. only

CAUTION: Changes or modifications to this device, not expressly approved by Icom Inc., could void your authority to operate this device under FCC regulations.

PRÉCAUTIONS

⚠ AVERTISSEMENT! NE JAMAIS connecter l'émetteur-récepteur à une alimentation CA au risque de provoquer un incendie ou un choc électrique.

⚠ AVERTISSEMENT! NE JAMAIS brancher l'émetteur-récepteur à une source d'alimentation de plus de 16 V CC, comme une source de 24 V CC. Cela pourrait causer un incendie ou endommager l'émetteur-récepteur.

⚠ AVERTISSEMENT! NE JAMAIS inverser la polarité du câble d'alimentation CC en le branchant à la source d'alimentation. Cela pourrait endommager l'émetteur-récepteur.

⚠ AVERTISSEMENT! NE JAMAIS sectionner le câble d'alimentation CC entre la prise CC de la face arrière de l'émetteur-récepteur et le porte-fusible. L'émetteur-récepteur peut être endommagé par la suite en cas de connexion inappropriée.

MISE EN GARDE: NE JAMAIS installer l'émetteur-récepteur à un emplacement où il pourrait gêner le fonctionnement normal du navire ou provoquer des blessures corporelles.

MAINTENIR l'émetteur-récepteur et le microphone à au moins 1 mètre du compas de route magnétique du navire.

NE PAS utiliser ou placer l'émetteur-récepteur dans des zones où la température est inférieure à -20° (-4°F) ou supérieure à $+60^{\circ}$ ($+140^{\circ}\text{F}$) ou dans des zones soumises au rayonnement solaire direct, telles le tableau de bord.

NE PAS nettoyer l'appareil avec des solvants agressifs tels que benzène ou alcool, susceptibles d'endommager les surfaces exposées du boîtier. En cas de dépôt de poussière ou de salissures sur l'émetteur-récepteur, il faut l'essuyer avec chiffon doux et sec.

NE PAS démonter ou modifier l'émetteur-récepteur pour quelque raison que ce soit.

ATTENTION! La face arrière de l'émetteur-récepteur chauffe en cas d'utilisation continue sur une longue durée.

Placer l'émetteur-récepteur hors de portée des enfants pour éviter toute utilisation inopinée.

ATTENTION! Le récepteur est conforme à la norme d'étanchéité IPX7*. Cependant, cette étanchéité n'est plus garantie après une chute de l'appareil en raison des fissures du boîtier ou des dommages au joint d'étanchéité et autres dommages éventuels consécutifs à un tel incident.

* À l'exception du connecteur d'alimentation CC, des fils d'entrée ou de sortie NMEA et des fils de sortie de fréquences audio.

TABLE OF CONTENTS

| | |
|---|-------------|
| FOREWORD | i |
| IMPORTANT | i |
| EXPLICIT DEFINITIONS..... | i |
| IN CASE OF EMERGENCY | ii |
| INSTALLATION NOTE..... | ii |
| RADIO OPERATOR WARNING | iii |
| AVERTISSEMENT POUR LES OPÉRATEURS RADIO..... | iv |
| FCC INFORMATION | v |
| NOTE..... | v |
| PRECAUTIONS..... | vi |
| PRÉCAUTIONS..... | vii |
| 1 OPERATING RULES | 1 |
| 2 PANEL DESCRIPTION | 2-6 |
| ■ Front panel | 2 |
| ■ Function display | 4 |
| ■ Microphone | 6 |
| ■ Softkey function..... | 6 |
| 3 PREPARATION | 7-8 |
| ■ Entering the MMSI code | 7 |
| ■ Entering the ATIS code (For Dutch and German version transceivers) | 8 |
| 4 BASIC OPERATION | 9-15 |
| ■ Selecting a Channel..... | 9 |
| ■ Adjusting the volume and squelch levels | 11 |

| | |
|---|--------------|
| ■ Receiving and transmitting..... | 12 |
| ■ Entering a Channel name | 13 |
| ■ Entering a Call channel data..... | 14 |
| ■ Microphone Lock function | 14 |
| ■ Adjusting the Backlight level..... | 15 |
| ■ Using the AquaQuake water draining function..... | 15 |
| 5 SCAN OPERATION | 16-17 |
| ■ Scan Types..... | 16 |
| ■ Setting Favorite channels..... | 17 |
| ■ Starting a scan | 17 |
| 6 DUALWATCH/TRI-WATCH | 18 |
| ■ Description | 18 |
| ■ Operation | 18 |
| 7 DSC OPERATION..... | 19-67 |
| ■ DSC address ID | 19 |
| ■ Entering position and time | 22 |
| ■ Making a Distress call | 23 |
| ■ Making DSC calls..... | 27 |
| ■ Receiving DSC calls | 52 |
| ■ Transmitted Call log..... | 59 |
| ■ Received Call log | 60 |
| ■ DSC Settings | 62 |
| ■ Making an Individual call using an AIS transponder .. | 66 |



TABLE OF CONTENTS (Continued)

| | |
|--|--------------|
| 8 MENU SCREEN OPERATION | 68–74 |
| ■ Using the Menu screen | 68 |
| ■ Menu screen items..... | 69 |
| ■ Radio Settings items | 70 |
| ■ Configuration items | 71 |
| 9 CONNECTIONS AND MAINTENANCE | 75–79 |
| ■ Connections | 75 |
| ■ Antenna..... | 77 |
| ■ Fuse replacement | 77 |
| ■ Cleaning | 77 |
| ■ Supplied accessories | 77 |
| ■ Mounting the transceiver..... | 78 |
| ■ MB-132 installation | 79 |
| 10 SPECIFICATIONS AND OPTIONS | 80–81 |
| ■ Specifications | 80 |
| ■ Options..... | 81 |
| 11 TROUBLESHOOTING | 82 |
| 12 CHANNEL LIST | 83 |
| 13 INFORMATION | 84 |
| ■ Country Code List | 84 |
| 14 TEMPLATE | 85 |
| INDEX | 87–89 |

◇ **Priorities**

- Read all rules and regulations pertaining to call priorities, and keep an up-to-date copy handy. Safety and distress calls take priority over all others.
- You must monitor Channel 16 when you are not operating on another channel.
- False or fraudulent distress calls are prohibited under law.

◇ **Privacy**

- Information overheard, but not intended for you, cannot lawfully be used in any way.
- Indecent or profane language is prohibited.

◇ **Radio licenses**

(1) SHIP STATION LICENSE

You may require a current radio station license before using the transceiver. It is unlawful to operate a ship station which is not licensed, but required to be.

If required, contact your dealer or the appropriate government agency for a Ship-Radiotelephone license application. This government-issued license states the call sign which is your craft's identification for radio purposes.

(2) OPERATOR'S LICENSE

A Restricted Radiotelephone Operator Permit is the license most often held by small vessel radio operators when a radio is not required for safety purposes.

If required, the Restricted Radiotelephone Operator Permit must be posted or kept with the operator. If required, only a licensed radio operator may operate a transceiver.

However, non-licensed individuals may talk over a transceiver if a licensed operator starts, supervises, ends the call and makes the necessary log entries.

A current copy of the applicable government rules and regulations is only required to be on hand for vessels in which a radio telephone is compulsory. However, even if you are not required to have these on hand it is your responsibility to be thoroughly acquainted with all pertinent rules and regulations.

■ Front panel

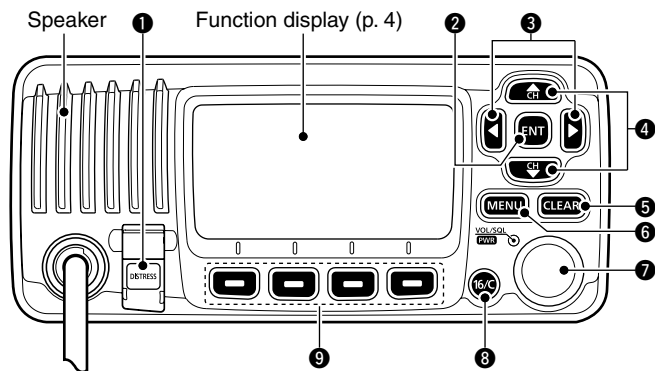

- 1 DISTRESS KEY [DISTRESS]** (pp. 23, 24)
 Hold down for 3 seconds to make a Distress call.
- 2 ENTER KEY [ENT]** (pp. 7, 10, 68)
 Push to set the entered data, selected item, and so on.
- 3 LEFT AND RIGHT KEYS [◀]/[▶]**
 - ➔ Push to change to the previous or next key function that is assigned to the softkeys. (p. 6)
 - ➔ Push to select the desired character or number in the table while in the channel name, position, MMSI code entry mode, and so on. (pp. 7, 13, 22)

- 4 UP AND DOWN/CHANNEL SELECT KEYS [▲•CH]/[▼•CH]**
 - ➔ Push to select the operating channels, Menu items, Menu settings, and so on. (pp. 12, 68)
 - ➔ Push to check Favorite channels, change the scanning direction or manually resume a scan. (p. 17)
- 5 CLEAR KEY [CLEAR]** (pp. 7, 13, 68)
 Push to cancel the entered data, or to return to the previous screen.
- 6 MENU KEY [MENU]** (p. 68)
 Push to enter or exit the Menu screen.
- 7 VOLUME AND SQUELCH SWITCH/POWER SWITCH [VOL/SQL•PWR]**
 - ➔ When the power is OFF, hold down for 1 second to turn ON power. (p. 12)
 - ➔ Hold down for 1 second to turn OFF power.
 - ➔ When the power is ON, push to enter the volume level adjustment mode.* (p. 11)
 - Each push of this switch toggles the mode between the volume level adjustment, squelch threshold level adjustment, operating channel selection and the LCD and key backlight brightness adjustment, if assigned.
 - ➔ Rotate to adjust the volume level.* (p. 11)

*The desired function can be assigned in the Menu screen.

8 CHANNEL 16/CALL CHANNEL KEY [16/C]

- ➔ Push to select Channel 16. (p. 9)
- ➔ Hold down for 1 second to select the Call channel. (p. 9)
 - “CALL” is displayed when the Call channel is selected.
- ➔ Hold down for 3 seconds to enter Call channel entry mode when the Call channel is selected. (p. 13)

9 SOFTKEYS

The desired functions as described below can be assigned in the Menu screen.

Scan [SCAN] (p. 17)

Push to start or stop a Normal or Priority scan.

Dualwatch/Tri-watch [DW] (p. 18)

- ➔ Push to start Dualwatch or Tri-watch.
- ➔ Push to stop Dualwatch or Tri-watch when either is activated.

High/Low [HI/LO] (p. 12)

Push to set the power to high or low.
 •Some channels are set to only low power.

Channel [CHAN]* (p. 9)

Push to select a regular channel.
 * For only IC-M323 and IC-M323G except for Australian version transceivers.

Channel/Weather channel [CHWX] (pp. 9, 11)

Push to selects and toggles the regular channel and Weather channel.

AquaQuake [AQUA] (p. 15)

Holding down to activate the AquaQuake to clear water away from the speaker grill.

Favorite channel [★] (p. 17)

- ➔ Push to set or clear the displayed channel as a Favorite (Tag) channel.
- ➔ Hold down for 3 seconds to clear or set all Favorite channels in the selected channel group.

Name [NAME] (p. 13)

Push to enter the channel name entry mode.

Backlight [BKLT] (p. 15)

Push to enter the LCD and key backlight brightness adjustment mode.
 • While in the adjustment mode, push [▲]/[▼]/[◀]/[▶] or rotate Dial to adjust the brightness of the LCD and key backlight.

LO/DX [LO/DX]* (p. 12)

Push to turn the Attenuator function ON or OFF.
 •“LOCAL” is displayed when the Attenuator function is ON.
 *For only U.S.A. and Australian version transceivers.

Log [LOG] (p. 60)

Push to enter “RCVD CALL LOG” in the DSC CALLS menu.

2 PANEL DESCRIPTION

■ Function display

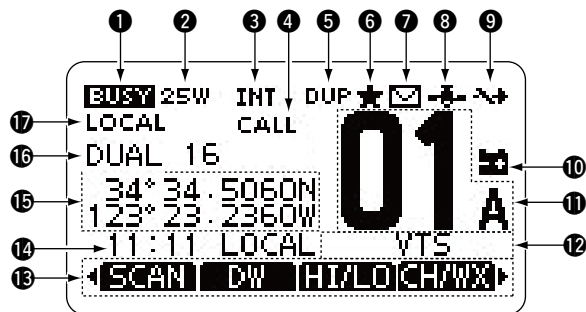

- 1 BUSY/TRANSMIT ICON** (p. 12)
➔ “BUSY” is displayed when receiving a signal or when the squelch is open.
➔ “TX” is displayed while transmitting.
- 2 POWER ICON** (p. 12)
➔ “25W” is displayed when high power is selected.
➔ “1W” is displayed when low power is selected.
- 3 CHANNEL GROUP ICON** (p. 10)
Shows which channel group is selected, INT, USA, CAN, ATIS or DSC, depending on the version.
➔ WX is displayed when the weather channel is selected.*
*For only U.S.A. and Australian version transceivers.
- 4 CALL CHANNEL ICON** (p. 9)
Displayed when the Call channel is selected.
- 5 DUPLEX ICON** (p. 10)
Displayed when a duplex channel is selected.
- 6 FAVORITE CHANNEL ICON** (p. 17)
Displayed when a Favorite (Tag) channel is selected.
- 7 MESSAGE ICON** (p. 60)
Blinks when there is an unread DSC message.
- 8 GPS ICON**
➔ Stays ON when the built-in GPS receiver* or an external GPS receiver is receiving valid position data.
*For only IC-M323G and IC-M324G.
➔ Blinks when searching for valid position data.
- 9 SWITCH ICON** (p. 63)
Displayed when the “CH 16 SWITCH” in DSC Settings is set to OFF.
- 10 LOW BATTERY ICON**
Blinks when the battery voltage drops to approximately 10 V DC or less.
- 11 CHANNEL NUMBER READOUT**
Shows the selected operating channel number.
• When a simplex channel is selected, “A” is displayed.
- 12 CHANNEL NAME FIELD**
The channel name is displayed, if entered. (p. 13)

13 KEY ICON (p. 6)

Shows the preset function of the softkeys on the front panel.

14 TIME ZONE INDICATOR

- Shows the current time when GPS data is received, or the time is manually entered.
 - When the GPS current time is invalid, “??” will blink every 2 seconds instead of current time. After 23.5 hours has passed, “NO TIME” is displayed.
 - “??” will blink every 2 seconds instead of the current time, after 4 hours have passed from the time when the time was manually entered. The manually entered time is held for only 23.5 hours, and after that, “NO TIME” is displayed.
- “LOCAL” is displayed when the offset time is set.
- “MNL” is displayed when the time is manually entered.
- “UTC” is displayed when the GGA, GLL, and GNS GPS sentence format is included in the GPS signal.
- The date information is displayed when the RMC GPS sentence format is included in the GPS signal.
- “NO TIME” is displayed when no GPS receiver is connected, and no time is manually entered.

NOTE for the IC-M323 and IC-M324:

These models do not come with a built-in GPS receiver. Therefore an external GPS receiver needs to be connected, or the time needs to be manually entered for the time zone indicator to be displayed.

15 POSITION INDICATOR

- Shows the current position when position data is received, or the position is manually entered.
 - When the position data is invalid, “??” may blink every 2 seconds instead of position. The last position is held for only 23.5 hours, and after that, “NO POSITION” is displayed.
 - “??” will blink every 2 seconds instead of position, after 4 hours have passed from the time when the position is manually entered. The manually entered position is held for only 23.5 hours, and after that, “NO POSITION” is displayed.
- “NO POSITION” is displayed when no GPS receiver is connected, and no position is manually entered.

16 SCAN INDICATOR

- “SCAN 16” is displayed during a Priority scan; “SCAN” is displayed during a Normal scan. (p. 17)
- “DUAL 16” is displayed during Dualwatch; “TRI 16” is displayed during Tri-watch. (p. 18)

17 LOCAL ICON (p. 12)

Displayed when the Attenuator function is turned ON.
*For only U.S.A. and Australian version transceivers.

2 PANEL DESCRIPTION

■ Microphone

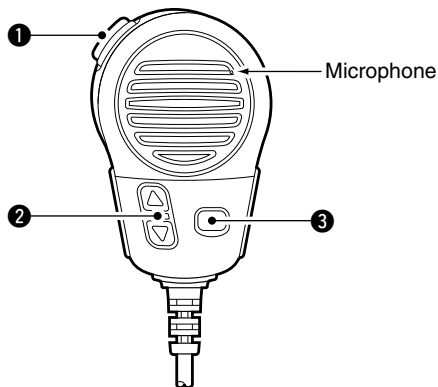

① PTT [PTT]

Hold down to transmit, release to receive. (p. 12)

② CHANNEL UP/DOWN KEYS [▲]/[▼]

- Push either key to check Favorite channels. (p. 12)
- Push either key to change scanning direction or manually resumes a scan. (p. 17)

③ TRANSMIT POWER KEY [HI/LO]

- Push to toggle the power high or low. (p. 12)
 - Some channels are set to only low power.
- While holding down [HI/LO], turn ON the power to turn the Microphone Lock function ON or OFF. (p. 14)

■ Softkey function

Various functions can be assigned to the softkeys.

When the key function is assigned, the key icon is displayed above the softkey, as shown below.

◇ Softkey function selection

When “◀” or “▶” is displayed beside the key icon, sequentially pushing [◀]/[▶] displays the previous or the next key function that is assigned to the softkey.

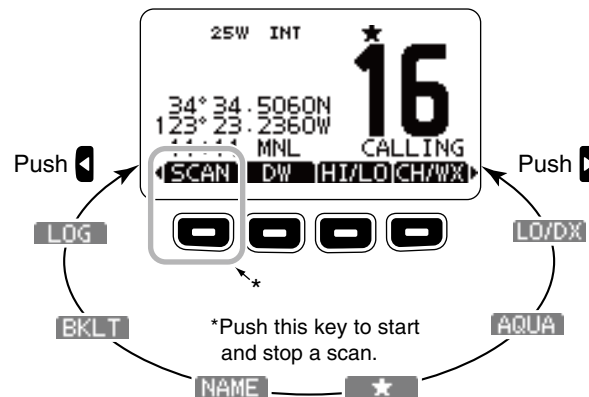

/// The order of the key icons may differ, depending on the presetting.

■ Entering the MMSI code

The 9 digit MMSI (Maritime Mobile Service Identity: DSC self ID) code can be entered at power ON.

This initial code setting can be made only once. After being set, it can be changed by only your dealer or distributor. If your MMSI code has already been entered, the following steps are not necessary.

- ① Hold down [PWR](Dial) to turn ON the power.
 - Three short beeps sound, and “NO DSC MMSI” is displayed.
- ② Push [ENT] to start the MMSI code entry.
 - Push [CLEAR] twice to cancel the entry, and go to the normal operating screen. In this case, the transceiver cannot make a DSC call. To enter the MMSI code, turn OFF the power, then turn it ON again.
- ③ Enter your MMSI code in the following way:
 - Select a desired number using Dial, or [▲]/[▼]/[◀]/[▶].
 - Push [ENT] or Dial to set it.
 - To move the cursor, select either arrow, “←” or “→,” then push [ENT] or Dial.

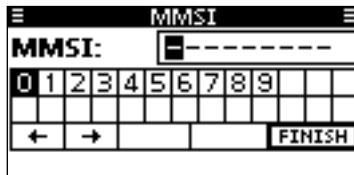

- ④ Repeat step ③ to enter all 9 digits.
- ⑤ After entering the 9 digit code, “FINISH” is automatically selected, and then push [ENT] or Dial to set it.
- ⑥ The “MMSI CONFIRMATION” screen is displayed.

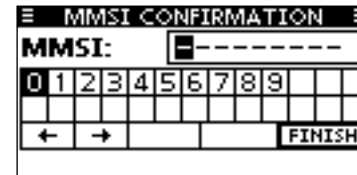

- ⑦ Enter your MMSI code again for confirmation.
 - Enter in the same way as steps ③ through ⑤.
- ⑧ When your MMSI code entry is successfully completed, the screen as shown below is briefly displayed.
 - After that, the normal operating screen is displayed.



The entered MMSI code can be checked in the MENU screen. (p. 69)

NOTE: Depending on the transceiver version, the ATIS code entry may be required after entering the MMSI code. See the next page for details.

3 PREPARATION

■ Entering the ATIS code (For Dutch and German version transceivers)

The 10 digit ATIS (Automatic Transmitter Identification System) code can be entered at power ON.

This initial code setting can be made only once. After being set, it can be changed by only your dealer or distributor. If your ATIS code has already been entered, the following steps are not necessary.

- ① After entered the MMSI code, "Push [ENT] to Register Your ATIS" is displayed.
- ② Push [ENT] to start entering the ATIS code.
 - Push [CLEAR] twice to cancel the entry, and go to the normal operating mode. In this case, the ATIS function is disabled. To enter the ATIS code, turn OFF the power, then turn it ON again.
- ③ Enter your ATIS code in the following manner:
 - Select a desired number using Dial, or [▲]/[▼]/[◀]/[▶].
 - Push [ENT] or Dial to set it.
 - To move the cursor, select either arrow, "←" or "→," then push [ENT] or Dial.

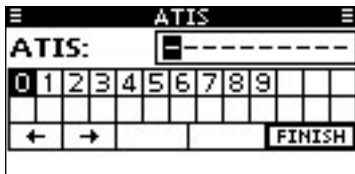

- ④ Repeat step ③ to enter all 10 digits.
- ⑤ After entering the 10 digit code, "FINISH" is automatically selected, and then push [ENT] or Dial to set it.
- ⑥ The "ATIS CONFIRMATION" screen is displayed.

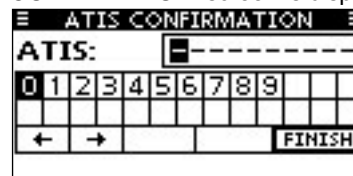

- ⑦ Enter your ATIS code again for confirmation.
 - Enter in the same manner as steps ③ through ⑤.
- ⑧ When your ATIS code is successfully entered, the screen as shown below is briefly displayed.
 - After that, the normal operating screen is displayed.



The entered ATIS code can be checked in the MENU screen. (p. 69)

■ Selecting a Channel

◇ Channel 16

Channel 16 is the distress and safety channel. It is used for establishing initial contact with a station and for emergency communications. Channel 16 is monitored during both Du-alwatch and Tri-watch. While standing by, you must monitor Channel 16.

- ➔ Push [16/C] to select Channel 16.
- ➔ Push [CH/WX]* to return to the screen displayed before you selected Channel 16, or push [▲]/[▼] to select an operating channel.

* [CHAN] is displayed instead of [CH/WX] for the IC-M323/IC-M323G except for Australian version.

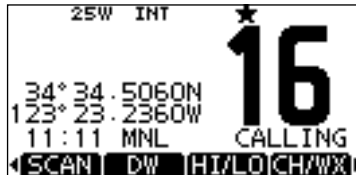

◇ Call channel

Each regular channel group has a separate leisure use Call channel. The Call channel is monitored during Tri-watch. The Call channel data can be entered. The channels used to store your most often used channel in each channel group, for quick recall. (p. 13)

- ➔ Hold down [16/C] for 1 second to select the Call channel of the selected channel group.
 - "CALL" and the Call channel number is displayed.
 - Each channel group has an independent call channel after entry. (p. 13)
- ➔ Push [CH/WX]* to return to the screen displayed before you selected Call channels, or push [▲]/[▼] to select an operating channel.

* [CHAN] is displayed instead of [CH/WX] for the IC-M323/IC-M323G except for Australian version.



Continued on the next page.

4 BASIC OPERATION

■ Selecting a Channel (Continued)

◇ Selecting the Channel group

There are preset international channels in the IC-M323/IC-M323G/IC-M324/IC-M324G. Except for the European versions, you can select a channel group suitable for your operating area, as described below.

- ① Push [MENU].
- ② Rotate Dial or push [▲]/[▼] to select “Radio Settings,” and then push [ENT].
- ③ Rotate Dial or push [▲]/[▼] to select “CHAN Group,” and then push [ENT].



- ④ Rotate Dial or push [▲]/[▼] to select the desired channel group, and then push [ENT].
 - U.S.A., (USA) International (INT), CAN (Canada), ATIS or DSC channel groups may be selected, depending on the transceiver version.
 - Push [BACK] to return to the previous screen.



- ⑤ Push [EXIT] to exit the Menu screen.
- ⑥ Push [▲]/[▼] to select a channel.
 - Pushing [▲]/[▼] on the microphone selects only Favorite channels.
 - “DUP” is displayed when a duplex channel is selected.
 - “A” is displayed when a simplex channel is selected.

Channel group icon is displayed



When the U.S.A. channel group is selected.

◇ Selecting a Weather channel

(For Only U.S.A. and Australian version transceivers)

The transceiver has 10 weather channels. These are used for monitoring broadcasts from NOAA. (National Oceanographic and Atmospheric Administration)

The transceiver can automatically detect a weather alert tone on the selected weather channel, or while scanning. (p. 16)

- ① Push [CH/WX] once or twice to select a weather channel.
 - “WX” is displayed when a weather channel is selected.
 - “WX ” is displayed when the Weather Alert function is ON. (p. 71)
- ② Push [▲]/[▼] to select a channel.
 - Pushing [▲]/[▼] on the microphone also select a channel.

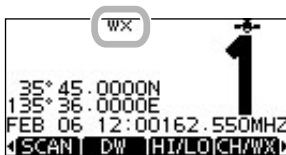

When weather alert is OFF.



When weather alert is ON.

■ Adjusting the volume and squelch levels

The volume and squelch levels can be adjusted with [VOL/SQL](Dial).

- ① Push [VOL/SQL](Dial) one or more times to display the volume or squelch adjustment screen.
- ② Rotate [VOL/SQL](Dial) or push [▲]/[▼]/[◀]/[▶] to adjust the volume or squelch level.
 - The transceiver has 20 volume levels and OFF.
 - The transceiver has 11 squelch levels. OPEN is completely open, 10 is tight squelch, 1 is loose squelch.
 - If no key is push for about 5 seconds, the transceiver sets the selected volume level, and returns to the normal mode.
- ③ Push [ENT] to set the level, and exit the volume adjustment mode.
 - Push [CLEAR] to cancel.

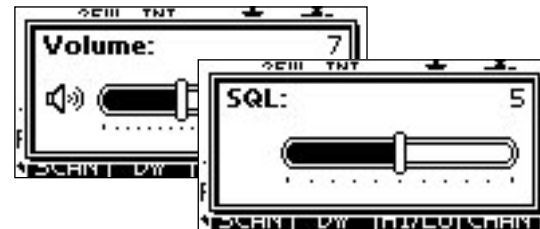

/// The desired function can be assigned to Dial. See page 72 for details.

4 BASIC OPERATION

■ Receiving and transmitting

CAUTION: Transmitting without an antenna will damage the transceiver.

- ① Hold down [PWR] (Dial) to turn ON the power.
- ② Set the audio and squelch levels. (p. 11)
 - First, open the squelch. Then, adjust the audio output level. After that, adjust the squelch level until the noise just disappears.
- ③ Change the channel group. (p. 10)
- ④ Push [▲]/[▼] to select a channel. (pp. 9, 10)
 - Pushing [▲]/[▼] on the microphone also selects a channel.
 - When receiving a signal, “**BUSY**” is displayed and audio is heard.
 - Further adjustment of the volume level may be necessary.
- ⑤ Push [LO/DX] to turn the receive Attenuator function ON or OFF, if necessary.
 - For only U.S.A. and Australian version transceivers.
 - “LOCAL” is displayed when the receive Attenuator function is ON.
- ⑥ Push [HI/LO] to select the output power, if necessary.
 - “25W” is displayed when high power is selected, and “1W” is displayed when low power is selected.
 - Choose low power for short range communications, choose high power for longer distance communications.
 - Some channels are for only low power.
- ⑦ Hold down [PTT] to transmit, then speak at your normal voice level.
 - “**TX**” is displayed.
 - Channel 70 cannot be used for transmission other than DSC.

- ⑧ Release [PTT] to receive.

Simplex channels, 3, 21, 23, 61, 64, 81, 82, and 83 CANNOT be lawfully used by the general public in U.S.A. waters.

IMPORTANT: To maximize the readability of your transmitted signal, pause a few seconds after pushing [PTT], hold the microphone 5 to 10 cm (2 to 4 inches) from your mouth and speak at your normal voice level.

✓ NOTE for the TOT (Time-out Timer) function

The TOT function inhibits continuous transmission beyond a preset time period after the transmission starts. 10 seconds before transmission is cutoff, a beep sounds to indicate the transmission will be shut down and “TOT” is displayed in the channel name field. Transmission is not possible for 10 seconds after this shut down.

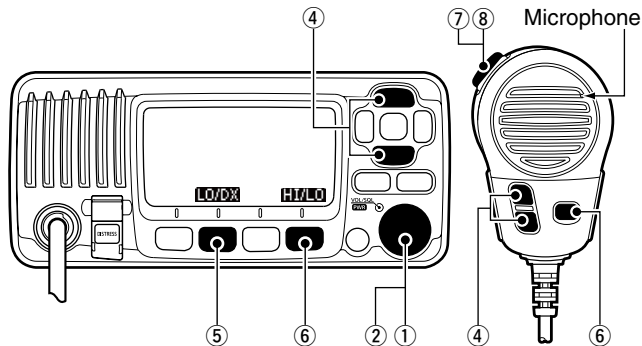

■ Entering a Channel name

Enter a name of up to 10 characters.

Capital letters, 0 to 9, some symbols (! " # \$ % & ' () * + , - . / [\] ^ _ : ; < = > ?) and a space can be entered.

- ① Push [▲]/[▼] to select a channel.
 - First, cancel the Dualwatch, Tri-watch or Scan function, if activated.
- ② Push [NAME] to open the channel name enter screen.
 - A cursor is displayed on the first character.
- ③ Enter the desired channel name in the following manner:
 - Select a desired character using Dial, or [▲]/[▼]/[◀]/[▶].
 - Push [ENT] or Dial to set it.
 - To move the cursor, select either arrow, “←” or “→,” then push [ENT] or Dial.
 - Push [123], [!\$?], or [ABC] to select a character group.
 - Select “SPACE,” then push [ENT] to enter a space.
 - Select “DELETE,” then push [ENT] to delete a character.
 - Push [CLEAR] to cancel and return to the previous screen.



- ④ Repeat step ③ to enter all characters.



- ⑤ Push [◀]/[▶]/[▲]/[▼] to select “FINISH,” then push [ENT] to set the name and return to the previous screen.



4 BASIC OPERATION

■ Entering a Call channel data

You can enter data in Call channel in each channel group for quick recall.

- ① Select the desired channel group (INT, USA, CAN, ATIS, or DSC) to be entered. (p. 10)
- ② Hold down [16/C] for 1 second to select the Call channel of the selected channel group.
 - “CALL” and the Call channel number is displayed.
- ③ Hold down [16/C] again for 3 seconds (until a long beep changes to 2 short beeps) to enter the Call channel entry mode.
- ④ Rotate Dial or push [▲]/[▼] to select a channel.

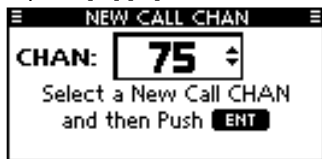

- ⑤ Push [ENT] to save the displayed channel as the Call channel.
 - Push [CLEAR] to cancel.

■ Microphone Lock function

The Microphone Lock function electrically locks [▲], [▼] and the [HI/LO] keys on the supplied microphone. This prevents accidental channel changes and function access.

- ➔ While holding down [HI/LO] on the microphone, hold down [PWR](Dial) to turn ON the transceiver and turn the Microphone Lock function ON or OFF.

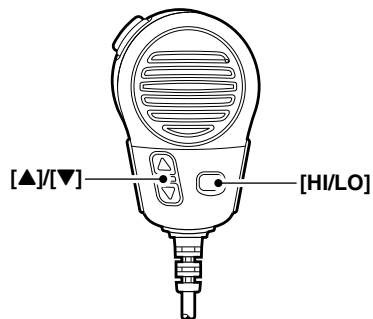

■ Adjusting the Backlight level

The function display and keys can be backlit for better visibility under low light conditions.

The backlight is adjustable in 7 levels and OFF.

The adjustment method, described below differs depending on the presetting.

- ➔ Push [BKLT] to show the backlight adjustment screen. Rotate Dial or push [▲]/[▼]/[◀]/[▶] to adjust the brightness of the LCD and key backlight, and then, push [ENT].
 - If no key operation is performed for about 5 seconds, the transceiver sets the selected backlight level, and returns to the normal mode.

When the Backlight function is assigned to the [VOL/SQL](Dial):

- ① Push [VOL/SQL](Dial) one or more times to display the backlight adjustment screen.
- ② Rotate [VOL/SQL](Dial) to adjust the brightness of the LCD and key backlight, and then, push [ENT].



/// The desired function can be assigned to Dial. See page 72 for details.

■ Using the AquaQuake water draining function

The AquaQuake water draining function clears water away from the speaker grill. Without this function, water may muffle the sound coming from the speaker. A buzzing sound is heard when this function is activated.

- ➔ While holding down [AQUA], the AquaQuake function is activated to clear water away from the speaker grill.
 - While holding down [AQUA], a low buzzing sounds to drain water, regardless of the volume level setting.
 - The transceiver keys, except [DISTRESS], are disabled while the AquaQuake function is activated.



When the AquaQuake function is activated.

■ Scan types

Scanning is an efficient way to locate signals quickly over a wide frequency range. The transceiver has a Priority scan and a Normal scan.

When the Weather Alert function* is ON, the weather channel is also checked while scanning. (p. 71)

*For only U.S.A and Australian version transceivers.

PRIORITY SCAN

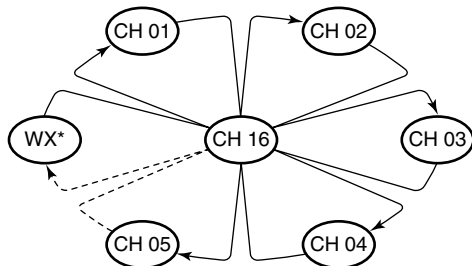

*When the weather alert function is activated.
(For only U.S.A and Australian version transceivers.)

The Priority scan sequentially searches through all Favorite channels while monitoring Channel 16. When a signal is detected on Channel 16, the scan pauses until the signal disappears. When a signal is detected on a channel other than Channel 16, the scan becomes a Dualwatch until the signal disappears.

Set the Favorite channels (scanned channel) before scanning. Clear the Favorite channels which inconveniently stop scanning, such as those for digital communication use. (Refer to the next page for details.)

/// Choose Priority or Normal scan in the Menu screen. (p. 70)

NORMAL SCAN

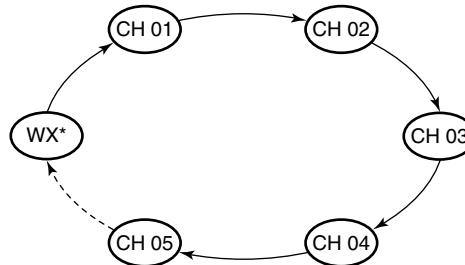

*When the weather alert function is activated.
(For only U.S.A and Australian version transceivers.)

The Normal scan, like the Priority scan, sequentially searches through all Favorite channels. However, unlike the Priority scan, Channel 16 is not checked unless it is set as a Favorite channel.

■ Setting Favorite channels

For more efficient scanning, add desired channels as Favorite channels, or clear the Favorite on unwanted channels. Channels that are not tagged will be skipped while scanning. Favorite channels can be independently assigned to each channel group (INT, USA, CAN, ATIS, or DSC).

- ① Select the desired channel group. (p. 10)
- ② Select the desired channel to be set as a Favorite channel.
- ③ Push [★] to set the displayed channel as a Favorite channel.
 - “★” is displayed on the display.
- ④ To cancel the Favorite channel setting, repeat step ③.
 - “★” disappears.

✓ Clearing (or setting) all Favorite channels

Hold down [★] for 3 seconds (until a long beep changes to 2 short beeps) to clear all Favorite channel settings in the selected channel group.

- Repeat above procedure to set all channels as Favorite channels.

■ Starting a scan

First, set the scan type (Priority or Normal scan) and scan resume timer in the Menu screen. (p. 70)

- ① Select the desired channel group. (p. 10)
- ② Set the Favorite channels, as described to the left.
- ③ Make sure the squelch is closed to start a scan.
- ④ Push [SCAN] to start a Priority or Normal scan.
 - “SCAN 16” is displayed during a Priority scan; “SCAN” is displayed during a Normal scan.
 - When a signal is detected, the scan pauses until the signal disappears, or resumes after pausing 5 seconds, depending on the setting. (Channel 16 is still monitored during a Priority scan.)
 - Push [▲]/[▼] on either transceiver or microphone, to check the scanning Favorite channels, change the scanning direction or manually resume the scan.
 - A beep tone sounds and “16” blinks when a signal is received on Channel 16 during a Priority scan.
- ⑤ To stop the scan, push [CLEAR] or repeat step ④.

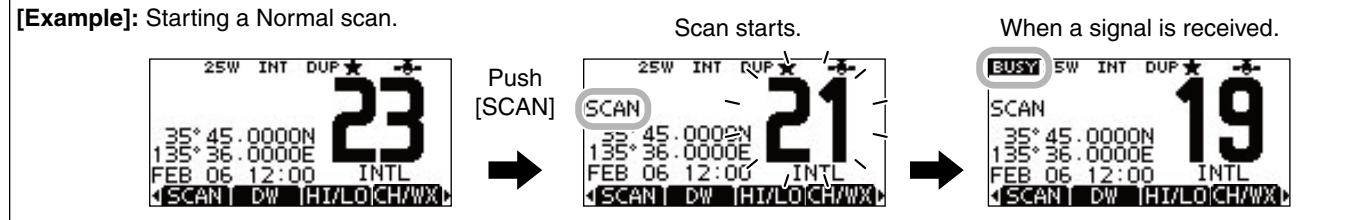

■ Description

Dualwatch monitors Channel 16 while you are receiving on another channel; Tri-watch monitors Channel 16 and the Call channel while receiving another channel. Dualwatch and Tri-watch are convenient for monitoring Channel 16 when you are operating on another channel.

DUALWATCH/TRI-WATCH SIMULATION

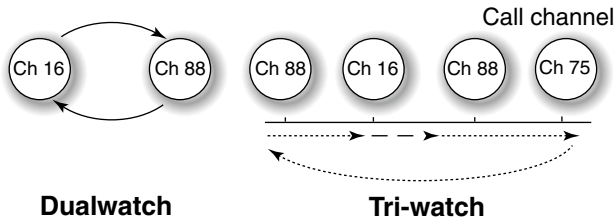

- If a signal is received on Channel 16, Dualwatch and Tri-watch pause on Channel 16 until the signal disappears.
- If a signal is received on the Call channel during Tri-watch, Tri-watch becomes Dualwatch until the signal disappears.
- To transmit on the selected channel during a Dualwatch or Tri-watch, hold down [PTT].

■ Operation

- ① Select Dualwatch or Tri-watch in the Menu screen. (p. 70)
- ② Push [▲]/[▼] to select the desired operating channel.
- ③ Push [DW] to start a Dualwatch or Tri-watch scan.
 - “DUAL 16” is displayed during Dualwatch; “TRI 16” is displayed during Tri-watch.
 - A beep tone sounds when a signal is received on Channel 16.
- ④ To cancel Dualwatch or Tri-watch, push [DW] again.

[Example]: Operating Tri-watch on INT Channel 25.

Tri-watch starts.

```

25W INT DUF *
TRI 16
35° 45.0000N 25
135° 36.0000E
FEB 06 12:00 TELEPHONE
[SCAN] DW [HI/LO/CH/WX]
  
```

Signal is received on Call channel.

```

BUSY 25W INT
CALL
TRI 16 75
35° 45.0000N
135° 36.0000E
FEB 06 12:00 CALLING
[SCAN] DW [HI/LO/CH/WX]
  
```

Tri-watch resumes after the signal disappears.

```

25W INT DUF *
TRI 16
35° 45.0000N 25
135° 36.0000E
FEB 06 12:00 TELEPHONE
[SCAN] DW [HI/LO/CH/WX]
  
```

Signal received on Channel 16 takes priority.

```

BUSY 25W INT DUF *
TRI 16 25
35° 45.0000N 25
135° 36.0000E
FEB 06 12:00 TELEPHONE
[SCAN] DW [HI/LO/CH/WX]
  
```

■ DSC address ID

◇ Entering an Individual ID

A total of 100 DSC address IDs can be entered and assigned a name of up to 10 characters.

- ① Enter “INDIVIDUAL ID” in the DSC SETTINGS menu.

⟨MENU⟩ ⇄ ⟨DSC Settings⟩ ⇄ ⟨Individual ID⟩
(Push [MENU].) (Rotate Dial, then push [ENT].)

- ② Push [ADD].

• The “INDIVIDUAL ID” entry screen is displayed.

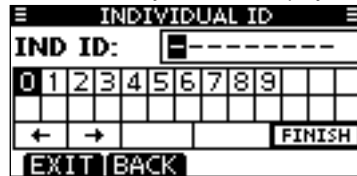

- ③ Enter a desired individual ID in the following way:

- Select a desired number using Dial, or [▲]/[▼]/[◀]/[▶].
- Push [ENT] or Dial to set it.
- To move the cursor, select either arrow, “←” or “→,” then push [ENT] or Dial.
- Push [EXIT] to return to the normal operating mode.
- Push [BACK] to return to the previous screen.

▨ The first digit is specified as ‘0,’ and the second digit is other than ‘0’ for a Group ID.

▨ The first two digits are ‘0’ for any Coast station ID.

- ④ Repeat step ③ to enter all 9 digits.

- ⑤ After entering the 9 digit code, push [ENT] or Dial to set it.
• The ID name entry screen is displayed.



- ⑥ Enter a desired 10 digit ID name in the following way:

- Select a desired character using Dial, or [▲]/[▼]/[◀]/[▶].
 - Push [ENT] or Dial to set it.
 - To move the cursor, select either arrow, “←” or “→,” then push [ENT] or Dial.
 - Push [123], [!\$?], or [ABC] to select a character group.
- ⑦ After entering the ID name, select “FINISH” using Dial, or [▲]/[▼]/[◀]/[▶], then push [ENT] or Dial to save it.
• The “INDIVIDUAL ID” list screen is displayed.



- ⑧ Push [MENU] to exit the MENU screen.

7 DSC OPERATION

■ DSC address ID (Continued)

◇ Entering a Group ID

- ① Enter "GROUP ID" in the DSC SETTINGS menu.

| | | | | |
|----------------|---|---------------------------------|---|-----------|
| ◀MENU | ⇄ | ◀DSC Settings | ⇄ | ◀Group ID |
| (Push [MENU].) | | (Rotate Dial, then push [ENT].) | | |

- ② Push [ADD].

- The "GROUP ID" entry screen is displayed.



- ③ Enter a desired group ID in the following way:

- Select a desired number using Dial, or [▲]/[▼]/[◀]/[▶].
- Push [ENT] or Dial to set it.
- To move the cursor, select either arrow, "←" or "→," then push [ENT] or Dial.
- Push [EXIT] to return to the normal operating mode.
- Push [BACK] to return to the previous screen.

▨ The first digit is specified as '0,' and the second digit is other than '0' for a Group ID.

▨ The first two digits are '0' for any Coast station ID.

- ④ Repeat step ③ to enter the specific 9 digits group code.

- ⑤ After entering the 9 digit code, push [ENT] or Dial to set it.
- Group ID name entry screen is displayed.



- ⑥ Enter a desired 10 digit ID name in the following way:

- Select a desired character using Dial, or [▲]/[▼]/[◀]/[▶].
- Push [ENT] or Dial to set it.
- To move the cursor, select either arrow, "←" or "→," then push [ENT] or Dial.
- Push [123], [!\$?], or [ABC] to select a character group.

- ⑦ After entering the ID name, select "FINISH" using Dial, or [▲]/[▼]/[◀]/[▶], then push [ENT] or Dial to save it.
- The "GROUP ID" list screen is displayed.



- ⑧ Push [MENU] to exit the MENU screen.

◇ **Deleting Individual and Group IDs**

- ① Enter "INDIVIDUAL ID" or "GROUP ID" in the DSC SETTINGS menu.

◀MENU▶ ⇄ ▶DSC Settings▶ ⇄ ▶Individual ID▶/▶Group ID▶
 (Push [MENU].) (Rotate Dial, then push [ENT].)

- When no address ID is entered, "No ID" is displayed. In this case, push [MENU] to exit the MENU screen.

- ② Rotate Dial or push [▲]/[▼] to select a desired ID name, then push [DEL].

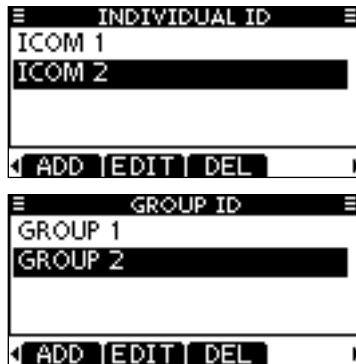

- ③ Push [OK] to delete the ID, and return to the "INDIVIDUAL ID" or "GROUP ID" list screen.
 - Push [CANCEL] to cancel it.



- ④ Push [MENU] to exit the MENU screen.

■ Entering position and time

A Distress call should include the ship's position and time. If no GPS receiver is connected and built-in GPS receiver* is not receiving valid position data, your position and UTC (Universal Time Coordinated) time should be manually entered. They are automatically included when a GPS receiver compatible with the NMEA 0183 (ver. 2.0 or later) format is connected.

*For only IC-M323G and IC-M324G.

- ▨ Manual entry is disabled when a GPS receiver is connected.
- ▨ Manually entered position and time will be held for only 23.5 hours.

① Enter "POSITION INPUT" in the DSC SETTINGS menu.

◀[MENU] ⇄ ◀[DSC Settings] ⇄ ◀[Position Input]
 (Push [MENU].) (Rotate Dial, then push [ENT].)

② Enter your latitude and longitude position using Dial, and [▲]/[▼]/[◀]/[▶].

- Select a desired number using Dial, or [▲]/[▼]/[◀]/[▶].
- Push [ENT] or Dial to set it.
- To move the cursor, select either arrow, "←" or "→," then push [ENT] or Dial.
- Select N (North latitude) or S (South latitude) when the cursor is on the 'N' or 'S' position.
- Select W (West longitude) or E (East longitude) when the cursor is on the 'W' or 'E' position.

- Push [EXIT] to return to the normal operating mode.
- Push [BACK] to return to the previous screen.



- ③ After entering the position, push [ENT] to save it.
- ④ The UTC time entry screen is displayed, enter the UTC time in the following way:
- Select a desired number using Dial, or [▲]/[▼]/[◀]/[▶].
 - Push [ENT] or Dial to set it.
 - To move the cursor, select either arrow, "←" or "→," then push [ENT] or Dial.

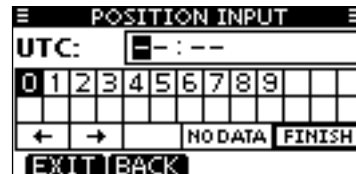

- ⑤ Push [ENT] or Dial to save your position and time.
- Return to the "DSC SETTINGS" screen.

■ Making a Distress call

A Distress call should be made if, in the opinion of the Master, that the ship or a person is in distress and requires immediate assistance.

NEVER MAKE A DISTRESS CALL IF YOUR SHIP OR A PERSON IS NOT IN AN EMERGENCY. A DISTRESS CALL SHOULD BE MADE ONLY WHEN IMMEDIATE HELP IS NEEDED.

◇ Simple call

- ① While lifting up the key cover, hold down [DISTRESS] for 3 seconds to transmit the Distress call.
 - While holding down [DISTRESS], count down beeps sound and both the key and display backlighting blink.
 - DSC channel (Channel 70) is automatically selected and the Distress call is transmitted.

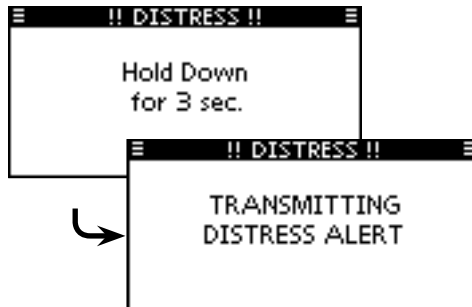

- ② After transmitting the call, the transceiver waits for an acknowledgment call.
 - The Distress call is automatically transmitted every 3.5 to 4.5 minutes, until an acknowledgement is received ('Call repeat' mode), or DSC Cancel call is made (p. 26).
 - Push [RESEND] to manually transmit the Distress repeat call.
 - Push [◀]/[▶] then push [INFO] to display the transmitted Distress call information.
 - Push [◀]/[▶] then push [PAUSE] to pause the 'Call repeat' mode, push [RESUME] to resume it.



- ③ After receiving the acknowledgment, push [ALARM OFF] then reply using the microphone.
 - ➔ A distress alert default contains:
 - Nature of distress: Undesignated distress
 - Position information: The latest GPS or manually entered position is held for 23.5 hours, or until the power is turned OFF.

7 DSC OPERATION

■ Making a Distress call (Continued)

◇ Making a Regular call

The nature of the Distress call should be included in the Distress call.

- ① Enter "DISTRESS CALL" in the DSC CALLS menu.

| |
|---|
| <MENU> ⇄ <DSC Calls> ⇄ <Distress Call> (Push [MENU].) (Rotate Dial, then push [ENT].) |
|---|

- ② Select the nature of the distress using Dial or [▲]/[▼], then push Dial or [ENT].

- 'Undesignated,' 'Fire,Explosion,' 'Flooding,' 'Collision,' 'Grounding,' 'Capsizing,' 'Sinking,' 'Adrift,' 'Abandoning ship,' 'Piracy' or 'Man Overboard' are selectable.
- The nature of the distress is stored for 10 minutes after selecting.
- Push [EXIT] to return to the normal operating mode.
- Push [BACK] to return to the previous screen.

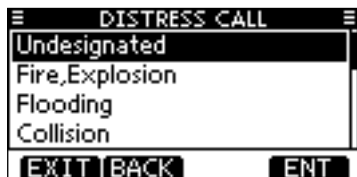

- ③ The Distress call confirmation screen is displayed.
- Rotate Dial or push [▲]/[▼] to see the hidden lines.

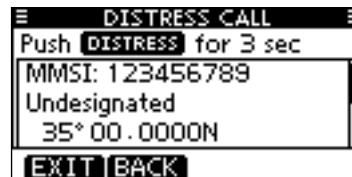

- ④ Hold down [DISTRESS] for 3 seconds to transmit the Distress call.

- While holding down [DISTRESS], count down beeps sound and both the key and display backlighting blink.
- The selected nature of the distress is stored for 10 minutes.

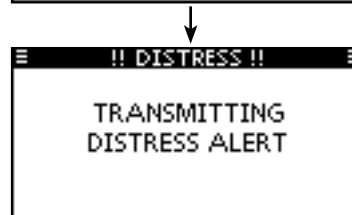

- ⑤ After transmitting the call, the transceiver waits for an acknowledgment call.
- The Distress call is automatically transmitted every 3.5 to 4.5 minutes, until an acknowledgement is received ('Call repeat' mode), or DSC cancel call is made (p. 26).
 - Push [RESEND] to manually transmit the Distress repeat call.
 - Push [◀]/[▶] then push [INFO] to display the transmitted Distress call information.
 - Push [◀]/[▶] then push [PAUSE] to pause the 'Call repeat' mode, push [RESUME] to resume it.



- ⑥ After receiving an acknowledgment call, push [ALARM OFF] then reply using the microphone.



- ➔ A distress alert contains:
- Nature of distress: Selected in step ②.
 - Position information: The latest GPS or manually entered position is held for 23.5 hours, or until the power is turned OFF.

When no GPS receiver is connected and built-in GPS receiver* is not receiving valid position data, and both position and time have been manually entered, the screen as shown below is displayed. Edit your latitude and longitude position and UTC time as follows:

*For only IC-M323G and IC-M324G.

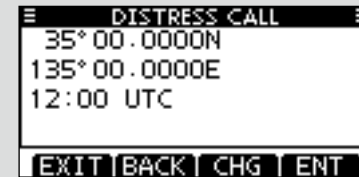

- ➔ Push [CHG], then edit your latitude and longitude position and UTC time.
- Select a desired number using Dial, or [▲]/[▼]/[◀]/[▶].
 - Push [ENT] or Dial to set it.
 - To move the cursor, select either arrow, “←” or “→,” then push [ENT] or Dial.
 - Select N (North latitude) or S (South latitude) when the cursor is on the ‘N’ or ‘S’ position.
 - Select W (West longitude) or E (East longitude) when the cursor is on the ‘W’ or ‘E’ position.



7 DSC OPERATION

■ Making a Distress call (Continued)

◇ Canceling a Distress call

- ① While waiting for an acknowledgment call, push [CANCEL].



- ② Push [CONTINUE].

- Push [BACK] to return to waiting for an acknowledgement call.



- ③ Push [FINISH].

- Push [EXIT] to return to waiting for an acknowledgement call.



- ④ The Distress cancel call is transmitted.

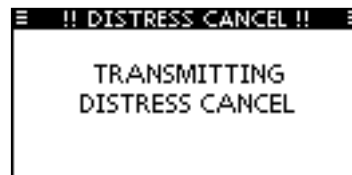

- ⑤ Channel 16 is automatically selected.

- Report your situation using the microphone.
- After the report, push [EXIT] to return to the normal operating mode.



■ Making DSC calls

/// To ensure correct operation of the DSC function, make sure you correctly set the CH70 SQL LEVEL. (p. 64)

◇ Making an individual call

The Individual call function allows you to make a DSC call to only a specific station.

- ① Enter "INDIVIDUAL CALL" in the DSC CALLS menu.

◀[MENU] → ◀[DSC Calls] → ◀[Individual Call]
(Push [MENU].) (Rotate Dial, then push [ENT].)

- ② Select a desired preset individual address, or "Manual Input," using Dial or [▲]/[▼], then push Dial or [ENT].
- The ID code for the Individual call can be entered first. (p. 19)
 - When "Manual Input" is selected, enter a desired 9 digit MMSI ID code for the individual you wish to call.
 - Push [EXIT] to return to the normal operating mode.
 - Push [BACK] to return to the previous screen.

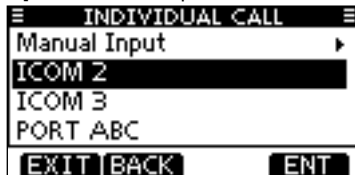

/// About Manual Entry:

Enter a desired individual ID in the following way:

- Select a desired number using Dial, or [◀]/[▶].
- Push [ENT] or Dial to set it.
- To move the cursor, select either arrow, "←" or "→," then push [ENT] or Dial.
- The first digit is specified as '0' for a Group ID. If a 9 digit Group ID is entered, an error beep sounds when pushing [ENT] or dial.
- The first two digits are '0' for any coast station ID.

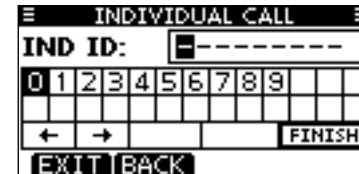

/// **NOTE:** When a coast station is selected in this step, the voice channel is automatically specified by the coast station. Therefore, skip step ③ and go directly to step ④.

- ③ Select a desired intership channel using Dial or [▲]/[▼], then push [ENT].
- Intership channels are already preset into the transceiver in the recommended order.

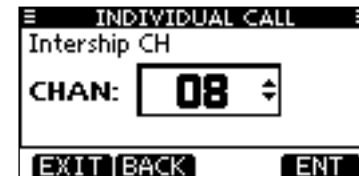

ⓘ Continued on the next page.

7 DSC OPERATION

■ Making DSC calls

◇ Making an Individual call (continued)

④ A confirmation screen is displayed.

- Confirm the call contents.

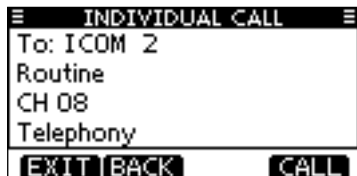

⑤ Push [CALL] to transmit the Individual call.

- If Channel 70 is busy, the transceiver stands by until the channel becomes clear.

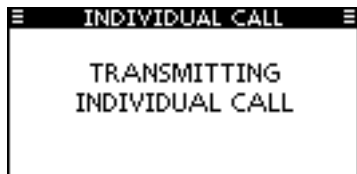

⑥ Standby on Channel 70 until an acknowledgement is received.

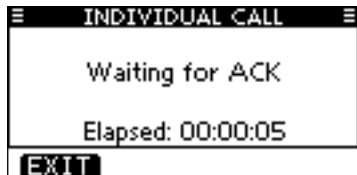

⑦ When the acknowledgement 'Able to comply' is received, alarm sounds and the screen below is displayed.



Push [ALARM OFF] to stop the alarm and then select the intership channel specified in step ③.

- A different intership channel will be selected if the station you called cannot use the channel.
- Reply using the microphone. And go to step ⑧.

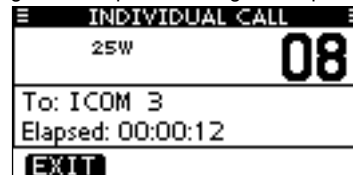

Or, when the acknowledgement 'Unable to comply' is received, alarm sounds and the screen below is displayed.

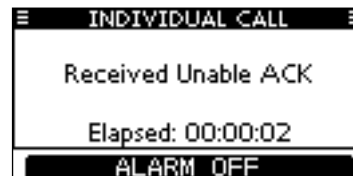

Push [ALARM OFF] to stop the alarm. Then push [EXIT] to return to the operating channel (before you entered the MENU screen).

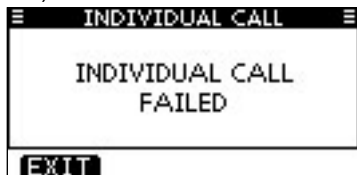

- ⑧ After communicating, push [EXIT] to return to the normal operating mode.

✓ **Tip**

When the optional MA-500TR CLASS B AIS TRANSPONDER is connected to your transceiver, you can make individual DSC calls to selected AIS targets on the transponder without needing to enter the target's MMSI code.

See pages 66 and 67 for more details.

7 DSC OPERATION

■ Making DSC calls (Continued)

◇ Making an Individual Acknowledgement

When you receive an Individual call, you can make an acknowledgement ('Able to Comply,' 'Propose New Channel,' or 'Unable to Comply') by using the on-screen prompts (Quick ACK). Also, you can send an acknowledgement through the MENU system (Manual ACK).

Quick ACK:

- ① When an Individual call is received, alarm sounds and the screen below is displayed.
Push [ALARM OFF] to stop the alarm.



- ② Push [ACK].

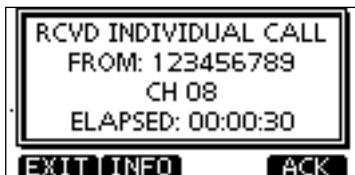

- ③ Select one of three options, then push [ENT].
 - Push [EXIT] to return to the normal operating mode.
 - Push [BACK] to return to the previous screen.



- Able to Comply: Make an acknowledgment call without any changes.
- Unable to Comply: You cannot make a communication. The Acknowledgement call ('Unable to Comply') can be automatically transmitted, if set. See page 62 for details.
- Propose New Channel: You can make an acknowledgement call, but you specify the intership channel, using Dial, or [▲]/[▼], then push [ENT].



- ④ The Individual ACK confirmation screen is displayed.
Push [CALL] to make an acknowledgement call.

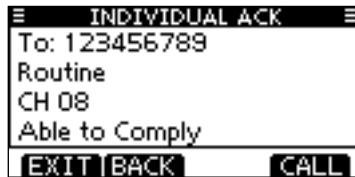

- ⑤ The screens shown below are displayed.

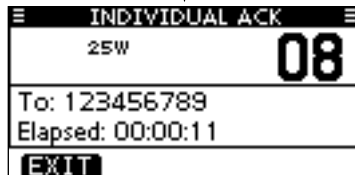
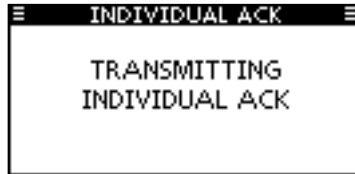

- ⑥ Reply to the call using the microphone.
⑦ Push [EXIT] to return to the normal operating mode.

Manual ACK:

- ① Enter "INDIVIDUAL ACK" in the DSC CALLS menu.

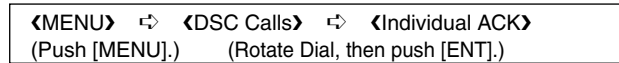

- When no Individual call has been received, the Individual ACK item will not be displayed.



- ② Select a desired individual address or ID code to reply to, using Dial or [▲]/[▼], then push [ENT].
- Push [EXIT] to return to the normal operating mode.
 - Push [BACK] to return to the previous screen.

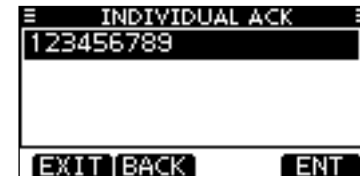

- ③ Do steps ③ to ⑦, as described in "Quick ACK:," beginning on the previous page.

7 DSC OPERATION

■ Making DSC calls (Continued)

◇ Making a Group call

The Group call function allows you to make a DSC signal to only a specific group.

- ① Enter “GROUP CALL” in the DSC CALLS menu.

| |
|--|
| <MENU> ⇄ <DSC Calls> ⇄ <Group Call> |
| (Push [MENU].) (Rotate Dial, then push [ENT].) |

- ② Select a desired preset group address or “Manual Input,” using Dial or [▲]/[▼], then push Dial or [ENT].

- The ID code for the Group call can be entered first. (p. 20)
- When “Manual Input” is selected, enter the 8 digit ID code for the group you wish to call.
- Push [EXIT] to return to the normal operating mode.
- Push [BACK] to return to the previous screen.



- ③ Select a desired intership channel using Dial or [▲]/[▼], then push [ENT].

- Intership channels are already preset into the transceiver in the recommended order.



About Manual Entry:

Enter a desired group ID in the following way:

- Select a desired number using Dial, or [◀]/[▶].
- Push [ENT] or Dial to set it.
- To move the cursor, select either arrow, “←” or “→,” then push [ENT] or Dial.
- The first digit is specified as ‘0,’ and the second digit is other than ‘0’ for a Group ID.
- The first two digits are ‘0’ for any Coast station ID.



- ④ A confirmation screen is displayed.
- Confirm the call contents.



- ⑤ Push [CALL] to transmit the Group call.
- If Channel 70 is busy, the transceiver stands by until the channel becomes clear.



- ⑥ After the Group call has been transmitted, the following screen is displayed.



- ⑦ Announce the information using the microphone.
- ⑧ After the announcement, push [EXIT] to return to the normal operating mode.

7 DSC OPERATION

■ Making DSC calls (Continued)

◇ Making an All Ships call

All ships that have DSC transceiver use Channel 70 as their 'listening channel.' When you want to announce a message to these ships, use the 'All Ships Call' function.

- ① Enter "ALL SHIPS CALL" in the DSC CALLS menu.

| |
|--|
| <MENU> ⇄ <DSC Calls> ⇄ <All Ships Call> (Push [MENU].) (Rotate Dial, then push [ENT].) |
|--|

- ② Select a desired category, using Dial or [▲]/[▼], then push Dial or [ENT].

- The selectable category may differ, depending on the presetting. Ask your dealer for the selectable categories.
- Push [EXIT] to return to the normal operating mode.
- Push [BACK] to return to the previous screen.



- ③ Select a desired traffic channel, using Dial or [▲]/[▼], then push Dial or [ENT].

- The selected channel is displayed.



- ④ A confirmation screen is displayed.

- Confirm the call contents.

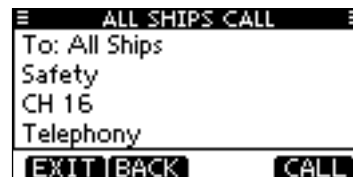

- ⑤ Push [CALL] to transmit the All Ships call.

- If Channel 70 is busy, the transceiver stands by until the channel becomes clear.



- ⑥ After the All Ships call has been transmitted, the following screen is displayed.

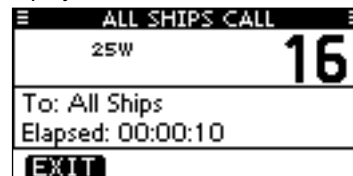

- ⑦ Announce the message using the microphone.

- ⑧ After the announcement, push [EXIT] to return to the normal operating mode.

◇ Making a Position Request Call

(For only U.S.A. and Australian version transceivers)

Make a Position Request Call when you want to know a specific ship's current position, and so on.

- 1 Enter "POSITION REQUEST" in the DSC CALLS menu.

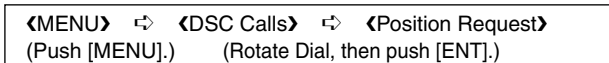

- 2 Select a desired preset individual address, or "Manual Input," using Dial or [▲]/[▼], then push Dial or [ENT].

- The ID code for the Position Request Call can be entered first. (p. 20)
- When "Manual Input" is selected, enter a desired 9 digit MMSI ID code for the individual you wish to call.
- Push [EXIT] to return to the normal operating mode.
- Push [BACK] to return to the previous screen.

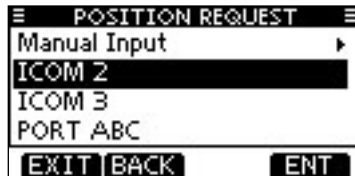

About Manual Entry:

Enter a desired individual ID in the following way:

- Select a desired number using Dial, or [▲]/[▼]/[◀]/[▶].
- Push [ENT] or Dial to set it.
- To move the cursor, select either arrow, "←" or "→," then push [ENT] or Dial.
- The first digit is specified as '0' for a Group ID. If a Group ID is entered, an error beep sounds after pushing [FINISH].
- The first two digits are '0' for any coast station ID.

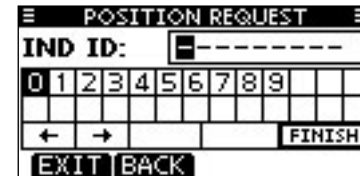

- 3 A confirmation screen is displayed.

- Confirm the call contents.



☞ Continued on the next page.

7 DSC OPERATION

■ Making DSC calls

◇ Making a Position Request call (continued)

④ Push [CALL] to transmit the Position Request Call.

- If Channel 70 is busy, the transceiver stands by until the channel becomes clear.



⑤ After the Position Request Call has been transmitted, the following screen is displayed.

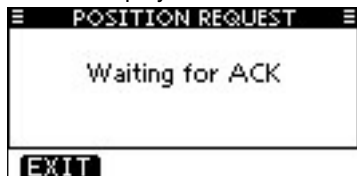

⑥ When the acknowledgement call is received, alarm sounds and the following screen is displayed.



⑦ Push [ALARM OFF] to stop the alarm, and then the screen as shown below is displayed.



⑧ Push [EXIT] to return to the normal operating mode.

◇ Making a Position Report Call

(For only U.S.A. and Australian version transceivers)

Make a Position Report Call when you want to announce your own position to a specific ship and receive an answer back.

- 1 Enter "POSITION REPORT" in the DSC CALLS menu.

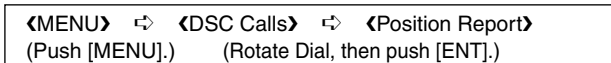

- 2 Select a desired preset individual address, or "Manual Input," using Dial or [▲]/[▼], then push Dial or [ENT].
 - The ID code for the Individual call can be entered first. (p. 20)
 - When "Manual Input" is selected, enter a desired 9 digit MMSI ID code for the individual you wish to call.
 - Push [EXIT] to return to the normal operating mode.
 - Push [BACK] to return to the previous screen.

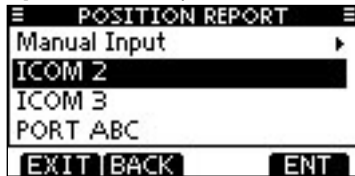

About Manual Entry:

Enter a desired individual ID in the following way:

- Select a desired number using Dial, or [▲]/[▼]/[◀]/[▶].
- Push [ENT] or Dial to set it.
- To move the cursor, select either arrow, "←" or "→," then push [ENT] or Dial.
- The first digit is specified as '0' for a Group ID. If a Group ID is entered, an error beep sounds after pushing [FINISH].
- The first two digits are '0' for any coast station ID.

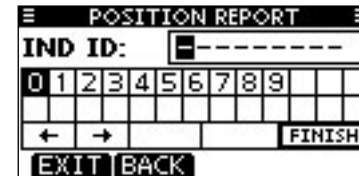

- 3 A confirmation screen is displayed.
 - Confirm the call contents.

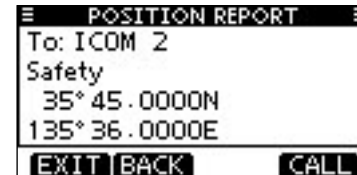

☞ Continued on the next page.

7 DSC OPERATION

■ Making DSC calls

◇ Making a Position Report call (continued)

④ Push [CALL] to make a Position Report Call.

- If Channel 70 is busy, the transceiver stands by until the channel becomes clear.



⑤ After the Position Report Call has been transmitted, the transceiver automatically returns to the normal operating mode.

When no GPS receiver is connected and built-in GPS receiver* is not receiving valid position data, and both position and time have been manually entered, the screen as shown below is displayed. Edit your latitude and longitude position and UTC time as follows:

*For only IC-M323G and IC-M324G.



➤ Push [CHG], then edit your latitude and longitude position and UTC time.

- Select a desired number using Dial, or [▲]/[▼]/[◀]/[▶].
- Push [ENT] or Dial to set it.
- To move the cursor, select either arrow, “←” or “→,” then push [ENT] or Dial.
- Select N (North latitude) or S (South latitude) when the cursor is on the ‘N’ or ‘S’ position.
- Select W (West longitude) or E (East longitude) when the cursor is on the ‘W’ or ‘E’ position.

◇ Making a Polling Request Call

(For only U.S.A. and Australian version transceivers)

Make a Polling Request Call when you want to know a specific vessel is in the communication area, or not.

- Enter "POLLING REQUEST" in the DSC CALLS menu.

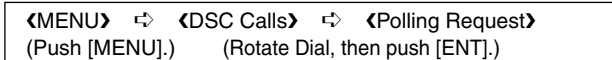

- Select a desired preset individual address, or "Manual Input," using Dial or [▲]/[▼], then push Dial or [ENT].
 - The ID code for the Individual call can be entered first. (p. 20)
 - When "Manual Input" is selected, enter a desired 9 digit MMSI ID code for the individual you wish to call.
 - Push [EXIT] to return to the normal operating mode.
 - Push [BACK] to return to the previous screen.

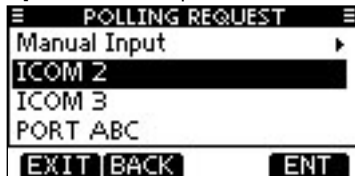

About Manual Entry:

Enter a desired individual ID in the following way:

- Select a desired number using Dial, or [▲]/[▼]/[◀]/[▶].
- Push [ENT] or Dial to set it.
- To move the cursor, select either arrow, "←" or "→," then push [ENT] or Dial.
- The first digit is specified as '0' for a Group ID. If a Group ID is entered, an error beep sounds after pushing [FINISH].
- The first two digits are '0' for any coast station ID.

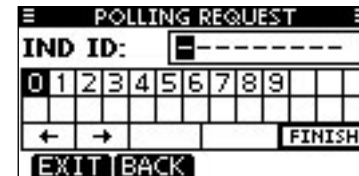

- A confirmation screen is displayed.
 - Confirm the call contents.

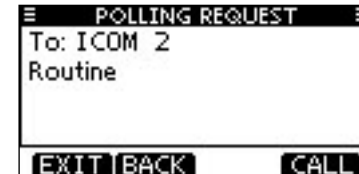

Continued on the next page.

7 DSC OPERATION

■ Making DSC calls

◇ Making a Polling Request call (continued)

- ④ Push [CALL] to make a Polling Request Call.
- If Channel 70 is busy, the transceiver stands by until the channel becomes clear.

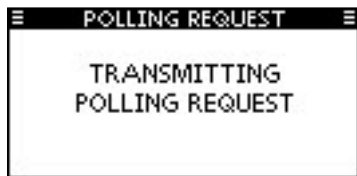

- ⑤ After the Polling Request Call has been transmitted, the following screen is displayed.

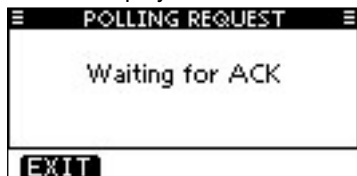

- ⑥ When the acknowledgement call is received, alarm sounds and the following screen is displayed.



- ⑦ Push [ALARM OFF] to stop the alarm, and then the screen as shown below is displayed.

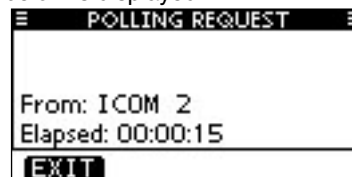

- ⑧ Push [EXIT] to return to the normal operating mode.

◇ Making a Test call

Testing on the exclusive DSC distress and safety calling channels should be avoided as much as possible. When testing on a distress or safety channel is unavoidable, you should indicate that these are test transmissions.

Normally the test call would require no further communications between the two stations involved.

- 1 Enter "TEST CALL" in the DSC CALLS menu.

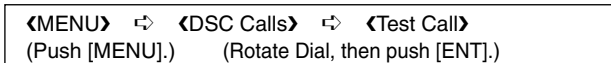

- 2 Select a desired preset individual address, or "Manual Input," then push Dial or [ENT].
 - The ID code for the Individual call can be entered first. (p. 19)
 - When "Manual Input" is selected, enter the 9 digit MMSI ID code for the individual you wish to call.
 - Push [EXIT] to return to the normal operating mode.
 - Push [BACK] to return to the previous screen.

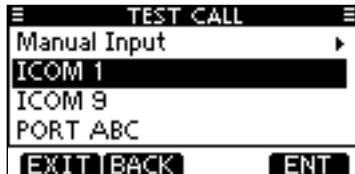

About Manual Entry:

Enter a desired address ID in the following way:

- Select a desired number using Dial, or [◀]/[▶].
- Push [ENT] or Dial to set it.
- To move the cursor, select either arrow, "←" or "→," then push [ENT] or Dial.
- The first digit is specified as '0' for a Group ID. If a 9 digit Group ID is entered, an error beep sounds when pushing [ENT] or dial.
- The first two digits are '0' for any Coast station ID.



- 3 A confirmation screen is displayed.
 - Confirm the call contents.

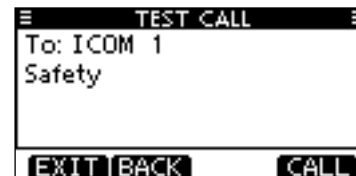

☞ Continued on the next page.

7 DSC OPERATION

■ Making DSC calls

◇ Making a Test call (continued)

④ Push [CALL] to make a Test call.

- If Channel 70 is busy, the transceiver stands by until the channel becomes clear.



⑤ After the Test call has been transmitted, the following screen is displayed.

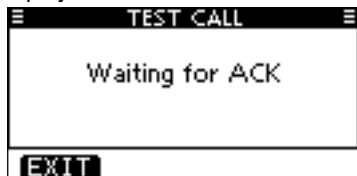

⑥ When the acknowledgement call is received, alarm sounds and the following screen is displayed.



⑦ Push [ALARM OFF] to stop the alarm, and then the screen as shown below is displayed.



⑧ Push [EXIT] to return to the normal operating mode.

◇ Making a Test Acknowledgement call

When the "TEST ACK" in DSC settings is set to 'Auto TX' (p. 62), the transceiver automatically transmits a reply call when a Test call is received.

Quick ACK:

- ① When a Test call is received, alarm sounds and the screen shown below is displayed.

Push [ALARM OFF] to stop the alarm.



- ② Push [ACK].
 - Push [EXIT] to return to the normal operating mode.
 - Push [INFO] to display the Test call information.

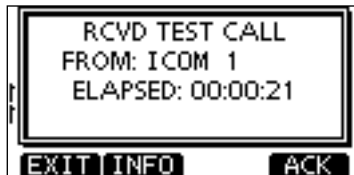

/// About Received call information:

- Push [EXIT] to return to the normal operating mode.
- Push [BACK] to return to the previous screen.
- Push [ACK] to go to the next step.



- ③ The Test ACK confirmation screen is displayed. Push [CALL] to make an acknowledgement call.



- ④ While transmitting the acknowledgement call, the screen shown below is displayed, and then returns to the normal operating mode.



Continued on the next page.

7 DSC OPERATION

■ Making DSC calls

◇ Making a Test Acknowledgement call (continued)

Manual ACK:

- ① Enter "TEST ACK" in the DSC CALLS menu.

◀MENU▶ ⇄ ▶DSC Calls▶ ⇄ ▶Test ACK▶
(Push [MENU].) (Rotate Dial, then push [ENT].)

- If no Test call is received, the Test ACK item will not be displayed.
- Push [EXIT] to return to the normal operating mode.
- Push [BACK] to return to the previous screen.

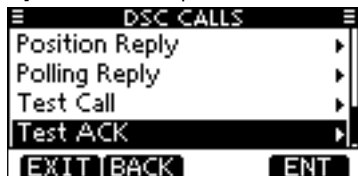

- ② Select a desired Test call to reply to, using Dial or [▲]/[▼], then push Dial or [ENT].

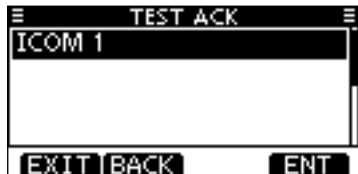

- ③ The Test ACK confirmation screen is displayed. Push [CALL] to make an acknowledgement call.



- ④ While transmitting the acknowledgement call, the screen shown below is displayed, and then returns to the normal operating mode.



◇ Making a Position Reply call

Make a Position Reply call when a Position Request call is received.

When the “POSITION ACK” in DSC Settings is set to ‘Auto TX’ (p. 62), the transceiver automatically transmits a reply call when a Position Request call is received.

Quick Reply:

- ① When a Position Request call is received, alarm sounds and the screen shown below is displayed.
Push [ALARM OFF] to stop the alarm.



- ② Push [ACK].
 - Push [EXIT] to return to the normal operating mode.
 - Push [INFO] to display the Test call information.



/// About Received call information:

- Push [EXIT] to return to the normal operating mode.
- Push [BACK] to return to the previous screen.
- Push [ACK] to go to the next step.



- ③ The Position Reply confirmation screen is displayed.
Push [CALL] to make a reply call.



- ④ While transmitting the reply call, the screen shown below is displayed, and then returns to the normal operating mode.



7 DSC OPERATION

■ Making DSC calls

◇ Making a Position Reply call (continued)

Manual Reply:

- ① Enter "POSITION REPLY" in the DSC CALLS menu.

◀MENU▶ ⇄ ▶DSC Calls▶ ⇄ ▶Position Reply▶
(Push [MENU].) (Rotate Dial, then push [ENT].)

- If no Position Request call is received, the Position Reply item will not be displayed.
- Push [EXIT] to return to the normal operating mode.
- Push [BACK] to return to the previous screen.



- ② Select a desired Position Request call to reply to, using Dial or [▲]/[▼], then push Dial or [ENT].

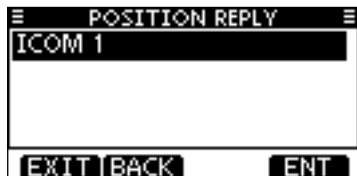

- ③ The Position Reply call confirmation screen is displayed. Push [CALL] to make an acknowledgement call.



- ④ While transmitting the reply call, the screen shown below is displayed, and then returns to the normal operating mode.



When no GPS receiver is connected and built-in GPS receiver* is not receiving valid position data, and both position and time have been manually entered, the screen as shown below is displayed. Edit your latitude and longitude position and UTC time as follows:

*For only IC-M323G and IC-M324G.



- Push [CHG], then edit your latitude and longitude position and UTC time.
 - Select a desired number using Dial, or [▲]/[▼]/[◀]/[▶].
 - Push [ENT] or Dial to set it.
 - To move the cursor, select either arrow, “←” or “→,” then push [ENT] or Dial.
 - Select N (North latitude) or S (South latitude) when the cursor is on the ‘N’ or ‘S’ position.
 - Select W (West longitude) or E (East longitude) when the cursor is on the ‘W’ or ‘E’ position.

7 DSC OPERATION

■ Making DSC calls (Continued)

◇ Making a Position Report Reply call

Make a Position Report Reply call when a Position Report call is received.

Quick Reply:

- ① When a Position Report call is received, alarm sounds and the screen as shown below is displayed.
Push [ALARM OFF] to stop the alarm.



- ② Push [ACK].
 - Push [EXIT] to return to the normal operating mode.
 - Push [INFO] to display the Position Report Request call information.



/// About Received call information:

- Push [EXIT] to return to the normal operating mode.
- Push [BACK] to return to the previous screen.
- Push [ACK] to go to the next step.

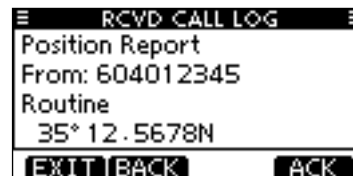

- ③ The Position Report Reply confirmation screen is displayed.
Push [CALL] to make a reply call.



- ④ While transmitting the reply call, the screen shown below is displayed, and then returns to the normal operating mode.



Manual Reply:

- ① Enter “REPORT REPLY” in the DSC CALLS menu.

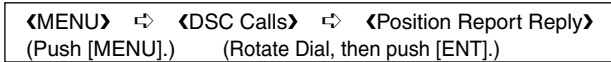

- If no Position Report Request call is received, the Position Report Reply item will not be displayed.
- Push [EXIT] to return to the normal operating mode.
- Push [BACK] to return to the previous screen.



- ② Select a desired Position Report Request call to reply to, using Dial or [▲]/[▼], then push Dial or [ENT].

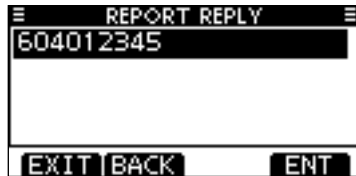

- ③ The Position Report Reply call confirmation screen is displayed.

Push [CALL] to make an acknowledgement call.

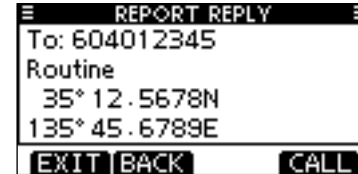

- ④ While transmitting the reply call, the screen shown below is displayed, and then returns to the normal operating mode.



7 DSC OPERATION

■ Making DSC calls (Continued)

◇ Making a Polling Request Reply call

Make a Polling Request Reply call when a Polling Request call is received.

When the "POSITION ACK" in DSC Settings is set to 'Auto TX' (p. 62), the transceiver automatically transmits a reply call when receiving a Polling Request call.

Quick Reply:

- ① When a Polling Request call is received, alarm sounds and the screen as shown below is displayed.
Push [ALARM OFF] to stop the alarm.

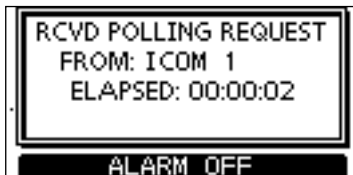

- ② Push [ACK].
 - Push [EXIT] to return to the normal operating mode.
 - Push [INFO] to display the Polling Request call information.

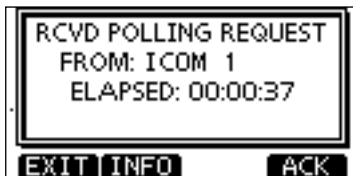

/// About Received call information:

- Push [EXIT] to return to the normal operating mode.
- Push [BACK] to return to the previous screen.
- Push [ACK] to go to the next step.



- ③ The Polling Request Reply confirmation screen is displayed.
Push [CALL] to make a reply call.

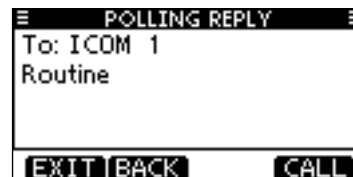

- ④ While transmitting the reply call, the screen shown below is displayed, and then returns to the normal operating mode.



Manual Reply:

- ① Enter "POLLING REPLY" in the DSC CALLS menu.

◀[MENU] ⇄ ▶ [DSC Calls] ⇄ ▶ [Polling Reply]
 (Push [MENU].) (Rotate Dial, then push [ENT].)

- If no Polling Request call is received, the Polling Reply item will not be displayed.
- Push [EXIT] to return to the normal operating mode.
- Push [BACK] to return to the previous screen.

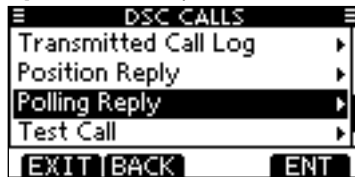

- ② Select a desired Polling Request call to be replied, using Dial or [▲]/[▼], then push Dial or [ENT].

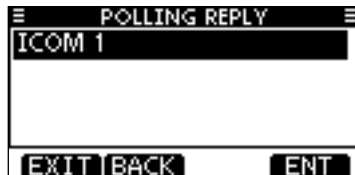

- ③ The Polling Request Reply call confirmation screen is displayed. Push [CALL] to make an acknowledgement call.

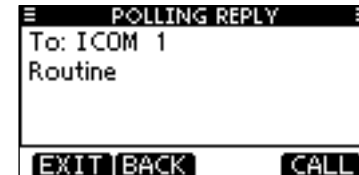

- ④ While transmitting the reply call, the screen shown below is displayed, and then returns to the normal operating mode.



■ Receiving DSC calls

◇ Receiving a Distress Call/Distress Acknowledgement

[Example]: Receiving a Distress Call.

When a Distress Call is received:

- The emergency alarm sounds for 2 minutes.
- “RCVD DISTRESS” is displayed and the backlight blinks.

① Push [ALARM OFF] to stop the alarm and the blinking backlight.

- Even if you do not push [ALARM OFF], the alarm stops after 2 minutes, and then the screen in step ② is displayed.



② Push a softkey to select your desired action.

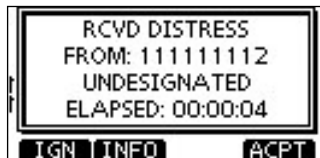

[IGN]

- Push to return to the normal operating mode.
 - The transceiver exits the DSC mode.
 - By pushing [PTT], the transceiver also exits the DSC mode.
 - “” continues to blink and the Call is stored in the Received Call Log.

[INFO]

- Push to display the Received call information. (p. 60)

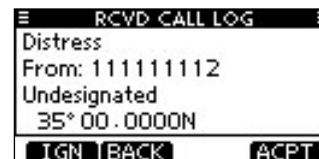

[ACPT]

- Push to accept the call. And then, push [CH 16] to change the operating channel to Channel 16, and then monitor it, as a coast station may require assistance.

- Even if you haven't pushed [CH 16] within 10 seconds, the operating channel automatically changes to Channel 16. (p. 63)



↓ Push

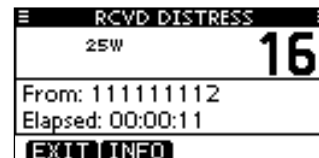

◇ Receiving a Distress Relay Call/Distress Relay Acknowledgement

[Example]: Receiving a Distress Relay call.

When a Distress Relay call is received:

- ➔ The emergency alarm sounds for 2 minutes.
- ➔ “RCVD DISTRESS RELAY” is displayed and the backlight blinks.

- ① Push [ALARM OFF] to stop the alarm and the blinking backlight.
 - Even if you do not push [ALARM OFF], the alarm stops after 2 minutes, and then the screen in step ② is displayed.



- ② Push a softkey to select your desired action.



[IGN]

- ➔ Push to return to the normal operating mode.
 - The transceiver exits the DSC mode.
 - By pushing [PTT], the transceiver also exits the DSC mode.
 - “” continues to blink and the Call is stored in the Received Call Log.

[INFO]

- ➔ Push to display the Received call information. (p. 60)

[ACPT]

- ➔ Push to accept the call. And then, push [CH 16] to change the operating channel to Channel 16, and then monitor it, as a coast station may require assistance.
 - Even if you haven’t pushed [CH 16] within 10 seconds, the operating channel automatically changes to Channel 16. (p. 63)



↓ Push

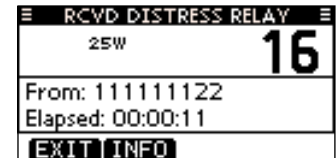

7 DSC OPERATION

■ Receiving DSC calls (Continued)

◇ Receiving an Individual Call

When an Individual Call is received:

- The alarm sounds for 2 minutes.
- “RCVD INDIVIDUAL CALL” is displayed. The backlight may blink for 2 minutes, depending on the received Category.

① Push [ALARM OFF] to stop the alarm and the blinking backlight.

- Even if you do not push [ALARM OFF], the alarm stops after 2 minutes, and then the screen in step ② is displayed.



② Push a softkey to select your desired action.



[IGN]

- Push to ignore the Call and return to the normal operating mode.
 - The transceiver exits the DSC mode.
 - “✉” continues to blink and the Call is stored in the Received Call Log.

[INFO]

- Push to display the Received call information. (p. 60)

[ACK]

- Push to display the “INDIVIDUAL ACK” screen to reply to the Call. Select one of three options, depending on your situation. See page 30 for details of the Individual Acknowledgement procedures.



When “INDIVIDUAL ACK” is set to “Auto TX (Unable),” the transceiver automatically replies to the Call. In that case, both the TX and RX calls are stored in the Transmitted and Received Call Logs.

◇ Receiving a Group Call/Geographical Area Call/All Ships Call

When a Group Call, Geographical Area Call, or All Ships Call is received:

- ➔ The alarm sounds for 2 minutes.
- ➔ “RCVD GROUP CALL,” “RCVD GEOGRAPHICAL,” or “RCVD ALL SHIPS CALL” is displayed. The backlight may blink for 2 minutes, depending on the received Category.

- ① Push [ALARM OFF] to stop the alarm and the blinking backlight.
 - Even if you do not push [ALARM OFF], the alarm stops after 2 minutes, and then the screen in step ② is displayed.

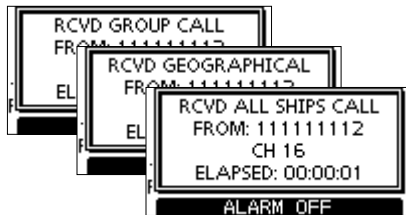

- ② Push a softkey to select your desired action.

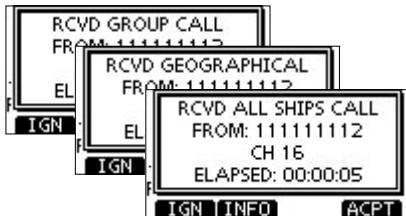

[IGN]

- ➔ Push to ignore the Call and return to the normal operating mode.
 - The transceiver exits the DSC mode.
 - “” continues to blink and the Call is stored in the Received Call Log.

[INFO]

- ➔ Push to display the Received call information. (p. 60)

[ACPT]

- ➔ Push to monitor the channel specified by the calling station for an announcement from the calling station.



/// Note for Geographical Area Call

When no GPS receiver is connected or if there is a problem with the external receiver, all Geographical Area Calls are received, regardless of your position.

7 DSC OPERATION

■ Receiving DSC calls (Continued)

◇ Receiving a Position Request Call

When a Position Request Call is received:

- The alarm sounds for 2 minutes.
- “RCVD POS REQUEST” is displayed. The backlight blinks for 2 minutes.

① Push [ALARM OFF] to stop the alarm and the blinking backlight.

- Even if you do not push [ALARM OFF], the alarm stops after 2 minutes, and then the screen in step ② is displayed.



② Push a softkey to select your desired action.



[IGN]

- Push to ignore the Call and return to the normal operating mode.
 - The transceiver exits the DSC mode.
 - “✉” continues to blink and the Call is stored in the Received Call Log.

[INFO]

- Push to display the Received call information. (p. 60)

[ACK]

- Push to display the “POSITION REPLY” screen and send a reply to the Call. (p. 45)



/// When “POSITION ACK” is set to “Auto TX,” the transceiver automatically replies to the Call. In that case, both the TX and RX calls are stored in the Transmitted and Received Call Logs.

◇ Receiving a Position Report Call

When a Position Report Call is received:

- ➔ The alarm sounds for 2 minutes.
- ➔ “RCVD POSITION REPORT” is displayed. The backlight blinks for 2 minutes.

- ① Push [ALARM OFF] to stop the alarm and the blinking backlight.
 - Even if you do not push [ALARM OFF], the alarm stops after 2 minutes, and then the screen in step ② is displayed.



- ② Push a softkey to select your desired action.



[EXIT]

- ➔ Push to ignore the Call and return to the normal operating mode.
 - The transceiver exits the DSC mode.
 - “☑” continues to blink and the Call is stored in the Received Call Log.

[INFO]

- ➔ Push to display the Received call information. (p. 60)

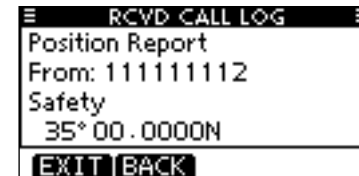

7 DSC OPERATION

■ Receiving DSC calls (Continued)

◇ Receiving a Polling Request call/Test Call

[Example]: Receiving a Polling Request call.

When a Polling Request call is received:

- The alarm sounds for 2 minutes.
- “RCVD POLLING REQUEST” is displayed. The backlight blinks for 2 minutes.

- ① Push [ALARM OFF] to stop the alarm and the blinking backlight.
 - Even if you do not push [ALARM OFF], the alarm stops after 2 minutes, and then the screen in step ② is displayed.

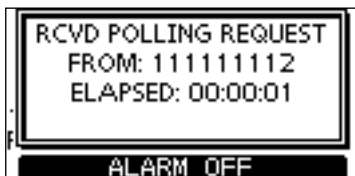

- ② Push a softkey to select your desired action.

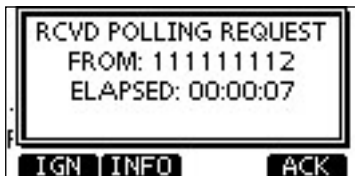

[IGN]

- Push to ignore the Call and return to the normal operating mode.
 - The transceiver exits the DSC mode.
 - “✉” continues to blink and the Call is stored in the Received Call Log.

[INFO]

- Push to display the Received call information. (p. 60)

[ACK]

- Push to display the “POLLING REPLY” screen to reply to the Call. (p. 50)

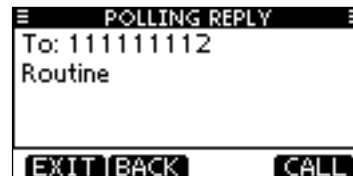

/// When “POSITION ACK” or “TEST ACK” is set to “Auto TX,” the transceiver automatically replies to the Call. In that case, both the TX and RX calls are stored in the Transmitted and Received Call Logs.

◇ Receiving a Test Acknowledgement Call

When a Test Acknowledgement Call is received:

- ➔ The alarm sounds for 2 minutes.
- ➔ “RCVD TEST ACK” is displayed. The backlight blinks for 2 minutes.

- ① Push [ALARM OFF] to stop the alarm and the blinking backlight.
 - Even if you do not push [ALARM OFF], the alarm stops after 2 minutes, and then the screen in step ② is displayed.



- ② Push a softkey to select your desired action.

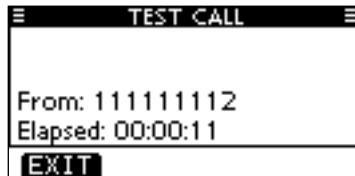

[EXIT]

- ➔ Push to return to the normal operating mode.
 - The transceiver exits the DSC mode.
 - “” continues to blink and the Call is stored in the Received Call Log.

■ Transmitted Call log

The transceiver automatically stores up to 50 transmitted calls, and the logs can be used as a supplement to your log-book.

- ① Enter “TX CALL LOG” in the DSC CALLS menu.

<MENU> ⇨ <DSC Calls> ⇨ <Transmitted Call Log>
 (Push [MENU].) (Rotate Dial, then push [ENT].)

- ② Push [▲]/[▼] to select the desired item, then push [ENT].
 - Push [BACK] to return to the previous screen.
 - Push [EXIT] to return to the normal operating mode.

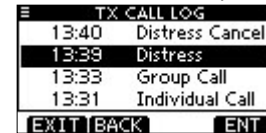

- ③ Rotate Dial to scroll the DSC message contents.



- ④ To delete the displayed DSC message, push [DEL].
 - The confirmation screen is displayed, then push [OK] to delete.
- ⑤ Push [EXIT] to return to the normal operating mode.

■ Received Call log

The transceiver automatically stores up to 50 distress messages and 50 other messages, and they can be used as a supplement to your logbook.

- While in the normal operating mode, “✉” blinks in the upper right corner of the LCD when there is an unread DSC message.

◇ Distress message

- ① Push [LOG] to enter “RCVD CALL LOG” in the DSC CALLS menu, or you can enter it through the Menu screen.

◀MENU▶ ⇄ ◀DSC Calls▶ ⇄ ◀Received Call Log▶
 (Push [MENU].) (Rotate Dial, then push [ENT].)

- ② Push [▲]/[▼] to select “Distress,” then push [ENT].
 - The Distress messages are stored in “Distress.”
 - “✉” is displayed when there are unread DSC messages.
 - “📁” is displayed when there are no unread DSC messages.
 - No icon is displayed when there are no DSC messages.
 - Push [BACK] to return to the previous screen.
 - Push [EXIT] to return to the normal operating mode.



- ③ Push [▲]/[▼] to select the desired item, then push [ENT].

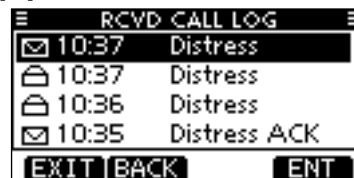

- ④ Rotate Dial to scroll the DSC message contents.



- ⑤ To delete the displayed DSC message, push [DEL].
 - The confirmation screen is displayed, then push [OK] to delete.
- ⑥ Push [EXIT] to return to the normal operating mode.

◇ Other messages

- ① Push [LOG] to enter “RCVD CALL LOG” in the DSC CALLS menu, or you can enter it through the Menu screen.

◀[MENU]▶ ⇨ [DSC Calls] ⇨ [Received Call Log]
 (Push [MENU].) (Rotate Dial, then push [ENT].)

- ② Push [▲]/[▼] to select “Others,” then push [ENT].
- The messages other than the Distress are stored in “Others.”
 - “✉” is displayed when there are unread DSC messages.
 - “🔒” is displayed when there are no unread DSC messages.
 - No icon is displayed when there are no DSC messages.
 - Push [BACK] to return to the previous screen.
 - Push [EXIT] to return to the normal operating mode.

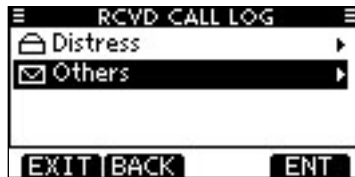

- ③ Push [▲]/[▼] to select the desired item, then push [ENT].
- The message in the unopened file has not been read.

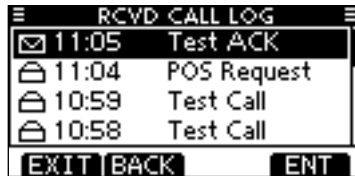

- ④ Rotate Dial to scroll the DSC message contents.
- The stored message has various information, depending on the DSC call type.



- ⑤ To delete the displayed DSC message, push [DEL].
- The confirmation screen is displayed, then push [OK] to delete.
- ⑥ Push [EXIT] to return to the normal operating mode.

■ DSC Settings

- ◇ Position Entry (See page 22)
- ◇ Add Individual ID/Group ID (See pages 19, 20)
- ◇ Delete Individual ID/Group ID (See page 21)

◇ Automatic Acknowledgement

These items set the Automatic Acknowledgement function to “Auto TX” or “Manual TX.”

When an Individual, Position Request, Polling Request, or Test Call is received, the transceiver automatically transmits an Individual Acknowledgement, Position Reply, Polling Reply or Test Acknowledgement Call, respectively.

When “INDIVIDUAL ACK” is set to “Auto TX,” the transceiver automatically transmits the Acknowledgment call including “Unable to Comply” (No Reason Given) after receiving the Individual call.

- ① Enter either “INDIVIDUAL ACK,” “POSITION ACK” or “TEST ACK” in the DSC Settings menu.

◀MENU▶ ⇄ ▶DSC Settings▶ ⇄ ▶Individual ACK▶
(Push [MENU].) (Rotate Dial, then push [ENT].)

◀MENU▶ ⇄ ▶DSC Settings▶ ⇄ ▶Position ACK▶

◀MENU▶ ⇄ ▶DSC Settings▶ ⇄ ▶Test ACK▶

- ② Rotate Dial or push [▲]/[▼] to select “Auto TX” or “Manual TX,” then push [ENT].
 - Push [BACK] to cancel and return to the DSC Settings menu.

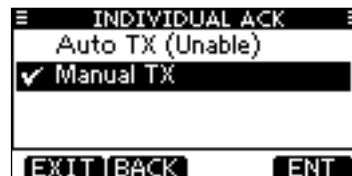

(default)

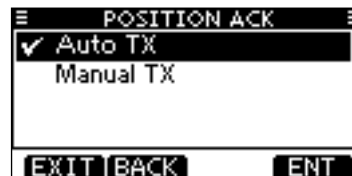

(default)

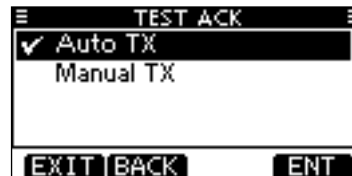

(default)

- ③ Push [EXIT] to return to the normal operating mode.

◇ Channel 16 Switch function

By regulation, after receiving a Distress call, the transceiver changes the operating channel to Channel 16. However, when this setting is set to “OFF,” the function enables the transceiver to remain on the operating channel, even after receiving a Distress call.

- ① Enter “CH 16 SWITCH” in the DSC Settings menu.

| | | | | |
|----------------|---|---------------------------------|---|---------------|
| ◀MENU | ↔ | ◀DSC Settings | ↔ | ◀CH 16 Switch |
| (Push [MENU].) | | (Rotate Dial, then push [ENT].) | | |

- ② Rotate Dial or push [▲]/[▼] to set the Channel 16 Switch function to “Auto (No Delay),” “10 Second Delay,” or “OFF;” then push [ENT].

- Push [BACK] to return to the previous screen.

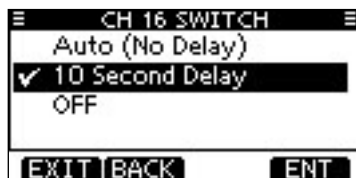

(default)

Auto (No Delay): After receiving a Distress call, and [ACPT] is pushed on the confirmation screen, the transceiver immediately changes to Channel 16.

10 Second Delay: After receiving a Distress call, and [ACPT] is pushed on the confirmation screen, the transceiver remains on the current operating channel for 10 seconds. After that, the transceiver automatically changes to Channel 16. (default)

OFF: Even after receiving a Distress call, the transceiver remains on the operating channel.

- “” is displayed.

- ③ Push [EXIT] to return to the normal operating mode.

7 DSC OPERATION

■ Receiving DSC calls (Continued)

◇ Alarm

Set the Alarm function ON or OFF, depending on the Category or Status.

- ① Enter "ALARM" in the DSC Settings menu.

◀MENU ▶ ⇨ ▶DSC Settings▶ ⇨ ▶Alarm▶
(Push [MENU].) (Rotate Dial, then push [ENT].)

- ② Rotate Dial or push [▲]/[▼] to select the status, then push [ENT].

- Push [BACK] to return to the previous screen.
- "Safety," "Routine," "Warning," "Self-Terminate," and "Discrete" are selectable. (default: ON)

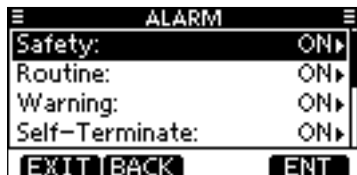

- ③ Rotate Dial or push [▲]/[▼] to set the Alarm setting to "ON" or "OFF".
- ④ Push [EXIT] to return to the normal operating mode.

◇ Channel 70 Squelch level

Set the squelch level on Channel 70.

The transceiver has 11 squelch levels between 1 (loose squelch) and 10 (tight squelch) and OPEN.

OPEN is completely open.

- ① Enter "CH 70 SQL LEVEL" in the DSC Settings menu.

◀MENU ▶ ⇨ ▶DSC Settings▶ ⇨ ▶CH 70 SQL Level▶
(Push [MENU].) (Rotate Dial, then push [ENT].)

- ② Rotate Dial or push [▲]/[▼] to adjust the squelch level until the noise just disappears, then push [ENT].

- Push [BACK] to cancel and return to the DSC Settings menu.

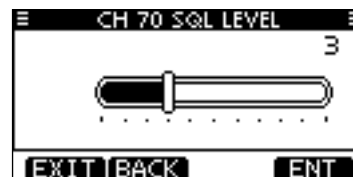

(default)

- ③ Push [EXIT] to return to the normal operating mode.

◇ DSC Loop Test

The DSC loop test function sends transmit DSC signals to the receive AF circuit to compare and check the TX and RX signals at the AF level.

- ① Enter “DSC LOOP TEST” in the DSC Settings menu.

| |
|--|
| ◀MENU▶ → ◀DSC Settings▶ → ◀DSC Loop Test▶ (Push [MENU].) (Rotate Dial, then push [ENT].) |
|--|

- ② Push [ENT] to start the DSC loop test.
- Push [BACK] to return to the previous screen.



- When the transmit DSC and receive DSC signals match, “OK” is displayed.
- ③ Push [EXIT] to return to the normal operating mode.

/// If “NG” is displayed in step ②, either or both TX and RX DSC circuits has a problem. In that case, you will have to send the transceiver to your nearest dealer for repair.

■ Making an Individual call using an AIS transponder

When the optional MA-500TR CLASS B AIS TRANSPONDER is connected to your transceiver, an individual DSC call can be transmitted to a selected AIS target, without needing to enter the target's MMSI code. In this case, the call type is automatically set to Routine.

See page 75 for connecting instructions.

/// To ensure correct operation of the DSC function, make sure you correctly set the CH70 SQL LEVEL. (p. 64)

Step 1: Transponder's operation

- ① Select a desired AIS target on the plotter, target list or danger list display.
 - You can also go to the next step whenever the detail screen of the AIS target is displayed.
 - Make sure the transceiver is in the normal operating mode. Otherwise, you cannot make an individual DSC call using the transponder.
- ② Push [DSC] to display the voice channel selection screen, and then push [▲] or [▼] to select a desired voice channel*.
 - Voice channels are already preset into the transponder in recommended order.

*When a coast station is selected in step ①, a voice channel will be specified by the coast station, therefore you cannot change the channel. The transponder will display "Voice Channel is specified by the Base station," in this case.



Transponder's display

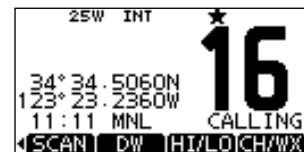

Transceiver's display

- ③ Push [DSC] to make an individual DSC call to the AIS target.

- If Channel 70 is busy, the transceiver stands by until the channel becomes clear.
- If the transceiver cannot make the call, the transponder will display "DSC Transmission FAILED."

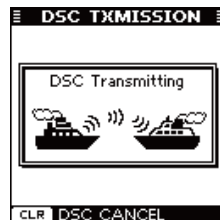

Transponder's display



Transceiver's display

- ④ After making the individual DSC call, the transponder will display “DSC Transmission COMPLETED.”
- Push [CLEAR] to return to the screen displayed before you entered the voice channel selection screen in step ②.
 - The transceiver stands by on Channel 70 until an acknowledgement is received.



Transponder's display

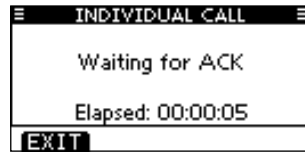

Transceiver's display

Step 2: Transceiver's operation

- ⑤ When the acknowledgement is received, alarm sounds.
- ➔ If the acknowledgement 'Able to comply' is received, push [ALARM OFF] to stop the alarm, and then select the intership channel specified in step ②.
 - A different intership channel will be selected if the station you called cannot use the channel.
 - To reply, push [PTT] and speak at your normal voice level.
 - You can check the MMSI code or the name, if entered, of the AIS target on the display.
 - ➔ If the acknowledgement 'Unable to comply' is received, push [ALARM OFF] to stop the alarm, and then “INDIVIDUAL CALL FAILED” is displayed.

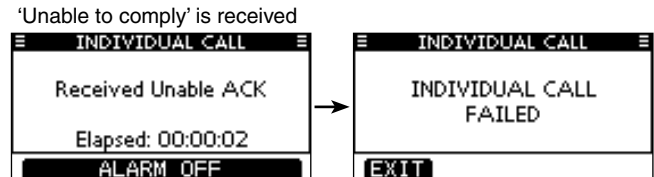
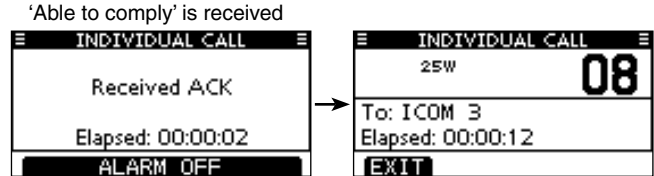

- ⑥ After your communication is finished, push [EXIT] to return to the normal operating mode.

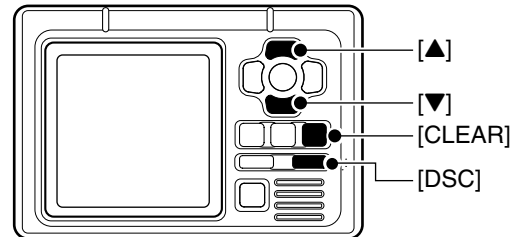

TRANSPONDER

■ Using the Menu screen

The Menu screen is used for entering infrequently changed values, function settings or making DSC calls.

In addition to this page, see pages 69 through 74 for details.



Menu lists

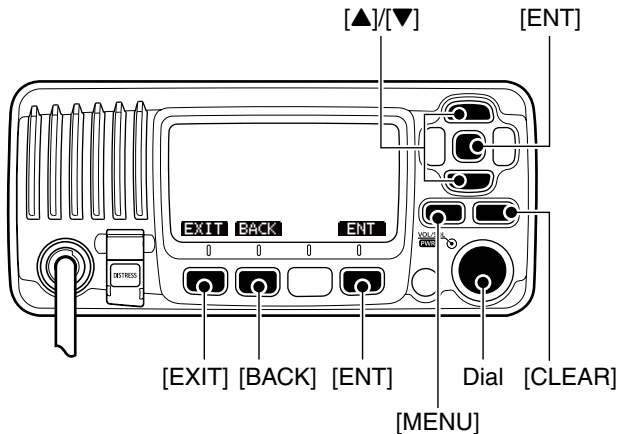

◇ Entering the Menu screen

Example: Set the channel group to “USA.”

① Push [MENU].

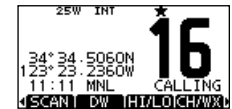

② Rotate Dial or push [▲]/[▼] to select the root item (Radio Settings), and then push [ENT].

- If [▲] or [▼] is continuously held down, the items are sequentially highlighted.



③ Rotate Dial or push [▲]/[▼] to select “CHAN Group,” and then push [ENT].



④ Rotate Dial or push [▲]/[▼] to select “USA,” and then push [ENT] to set it.

- “✓” is displayed next to “USA.”



⑤ Push [EXIT] to exit the Menu screen.

- Push [CLEAR] or [BACK] to return to the previous screen.

■ Menu screen items

The Menu screen contains the following items.

◇ DSC Calls

| Item | Ref. | Item | Ref. |
|--------------------------------|-------|---------------------------------------|-------|
| • Individual Call | p. 27 | • Received Call Log | p. 60 |
| • Individual ACK* ¹ | p. 31 | • Position Request Call* ² | p. 35 |
| • Group Call | p. 32 | • Position Report Call* ² | p. 37 |
| • All Ships Call | p. 34 | • Polling Request Call* ² | p. 59 |
| • Distress Call | p. 23 | • Test Call | p. 41 |
| • Transmitted Call Log | p. 59 | • Test ACK* ¹ | p. 43 |

*¹Displayed only after receiving a corresponding call.

*²For only U.S.A and Australian version transceivers.

◇ DSC Settings

| Item | Ref. | Item | Ref. |
|--------------------------------|-------|-------------------|-------|
| • Position Input* ³ | p. 22 | • Test ACK | p. 62 |
| • Individual ID | p. 19 | • CH 16 Switch | p. 63 |
| • Group ID | p. 20 | • Alarm | p. 64 |
| • Individual ACK | p. 62 | • CH 70 SQL Level | p. 64 |
| • Position ACK | p. 62 | • DSC Loop Test | p. 65 |

*³Displayed only when no GPS information is received.

◇ Radio Settings

| Item | Ref. | Item | Ref. |
|------------------|-------|--------------------------|-------|
| • Scan Type | p. 70 | • CHAN Group | p. 70 |
| • Scan Timer | p. 70 | • WX Alert* ² | p. 71 |
| • Dual/Tri-Watch | | | |

◇ Configuration

| Item | Ref. | Item | Ref. |
|--------------------|-------|--------------------|-------|
| • Backlight | p. 71 | • UTC Offset | p. 73 |
| • Display Contrast | p. 71 | • Inactivity Timer | p. 73 |
| • Key Beep | p. 71 | • NMEA Output | p. 74 |
| • Key Assignment | p. 72 | • Remote ID | p. 74 |

◇ MMSI/GPS Info

The transceiver shows the preset MMSI and ATIS*⁴ codes and GPS information*⁵.

If the code is not entered, “NO DSC MMSI” or “NO ATIS MMSI”*⁴ is displayed.

*⁴ Displayed only for the Dutch and German version transceivers.

*⁵ Displayed only when an external GPS receiver or built-in GPS receiver is receiving valid position data.

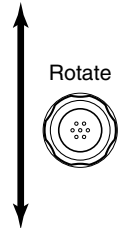

■ Radio Settings items

◇ Scan type

The transceiver has two scan types, Normal scan and Priority scan. A Normal scan searches all Favorite channels in the selected channel group. A Priority scan sequentially searches all Favorite channels, while monitoring Channel 16.

- The default setting is different depending on the transceiver versions.

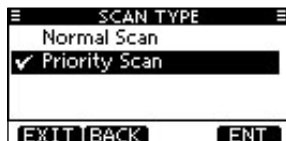

◇ Scan resume timer

(Default: OFF)

The scan resume timer can be selected as a pause (OFF) or timer scan (ON). When OFF is selected, the scan pauses until the signal disappears.

- **Normal scan** When ON is selected, the scan pauses for 5 seconds and then resumes, even if a signal has been received on any channel.
- **Priority scan** When ON is selected, the scan pauses for 5 seconds and then resumes, even if a signal has been received on any channel other than Channel 16.



◇ Dual/Tri-watch

(Default: Dualwatch)

This item can be selected as Dualwatch or Tri-watch. (p. 18)



◇ Channel Group

Except for the European version, a channel group suitable for your operating area can be selected. Depending on the transceiver version, INT, USA, CAN, ATIS, or DSC may be selectable.

See page 10 for details.

- The screen below shows the U.S.A version.



◇ **Weather alert**

(For only U.S.A. and Australian version transceivers)

A NOAA broadcast station transmits a weather alert tone before important weather information.

After the transceiver detects the alert, “WX ☁” blinks until the transceiver is operated.

- “WX ☁” is displayed instead of “WX” when the function is ON.
(Default: OFF)

ON with Scan: The preset weather channels are sequentially checked while scanning.

ON: The previously selected (last used) weather channel is checked while scanning.

OFF: The transceiver does not detect a weather alert tone.

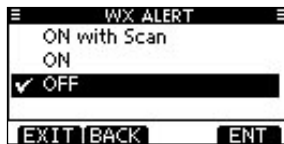

■ **Configuration items**

◇ **Backlight**

(Default: 7)

The function display and keys can be backlit for better visibility under low light conditions.

The backlight can be set to 7 levels and OFF.

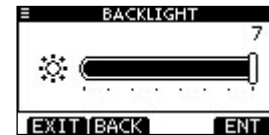

◇ **Display contrast**

(Default: 5)

This item adjusts the contrast of the LCD in 8 steps.

Level 1 is the lowest contrast, and level 8 is the highest contrast.

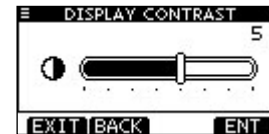

◇ **Key Beep**

(Default: ON)

You can turn OFF beep tones for silent operation, or you can turn ON the tones to have confirmation beeps sound when a key is pushed.



8 MENU SCREEN OPERATION

■ Configuration items (Continued)

◇ Key Assignment

Desired functions can be assigned to Dial and the softkeys.

- ① When the “KEY ASSIGNMENT” screen is displayed, rotate Dial or push [▲]/[▼] to select “Dial” or “Softkeys,” and then push [ENT].



- ② Rotate Dial or push [▲]/[▼] to select the desired position, and then push [ENT].
 - To return to the default, select “Set default” and push [ENT].

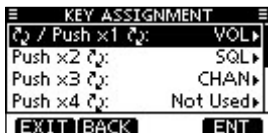

For “Dial” assignment

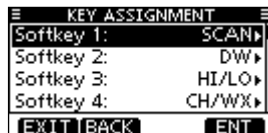

For “Softkeys” assignment

- ③ Rotate Dial or push [▲]/[▼] to select an option, and then push [ENT] to set it.
 - “✓” is displayed next to the selected option.



For “Dial” assignment

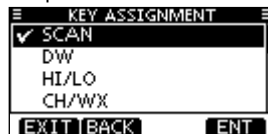

For “Softkeys” assignment

* [CHAN] is displayed instead of [CH/WX] for the IC-M323 and IC-M323G except for Australian version.

- ④ Push [EXIT] to exit the Menu screen.
 - Push [CLEAR] or [BACK] to return to the previous screen.

• Dial assignment

The Audio volume (VOL), squelch (SQL), channel selection (CHAN), and LCD backlight level (Backlight) functions can be assigned to any one of 4 sequential positions on Dial. Pushing Dial 1 to 4 times sequentially selects the desired function, and rotating Dial adjusts the level or selects a value or number.

For example:

- VOL is assigned to the 1st position, and pushing Dial once selects VOL. The VOL screen adjust screen is displayed and rotating Dial adjusts the audio volume.

- CH is assigned to the 3rd position, and pushing Dial three times selects CH. The channel number is displayed and rotating Dial will select the desired channel.

You can assign VOL, SQL, CH/WX*, and Backlight to any one of the 1st, 2nd, 3rd, or 4th sequential positions.

Repeatedly pushing Dial sequentially displays all the functions in the order they are assigned, and skips any functions assigned as Not Used.

* [CHAN] is displayed instead of [CH/WX] for the IC-M323 and IC-M323G except for Australian version.

• **Softkey assignment**

The desired function can be assigned to the softkey function. The assigned function can be used when its key icon is displayed.

See page 3 for details of the assignable key functions.

◇ **UTC Offset** (Default: 00:00)

Set the offset time between the UTC (Universal Time Coordinated) and your local time to between -14:00 and +14:00 (in 1 minute steps).



◇ **Inactivity Timer**

Set the inactivity timer to between 1 and 10 minutes (in 1 minute steps) or OFF for a "Not DSC Related" item, and set it to between 1 and 15 minutes (in 1 minute steps) or OFF for a "DSC Related" item.

- ① When the "INACTIVITY TIMER" screen is displayed, rotate Dial or push [▲]/[▼] to select "Not DSC Related" or "DSC Related," and then push [ENT].
- ② Rotate Dial or push [▲]/[▼] to select the option, and then push [ENT] to set it.
 - "✓" is displayed next to the selected option.

- ③ Push [EXIT] to exit the Menu screen.
 - Push [CLEAR] or [BACK] to return to the previous screen.

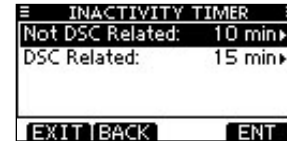

• **Not DSC Related** (Default: 10 min)

When the LCD displays a screen other than the normal operation screen, or one not related to DSC, and no key operation occurs for this set period, the transceiver automatically returns to the normal operating screen.



• **DSC Related** (Default: 15 min)

When the LCD displays the screen related to DSC, and no key operation occurs for this set period, except during distress operation, the transceiver automatically returns to the normal operating screen.



8 MENU SCREEN OPERATION

■ Configuration items (Continued)

◇ NMEA Output

Select the Data Output function option for a NMEA output port.

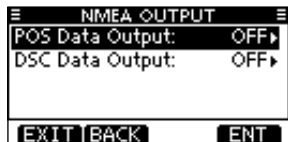

• POS data output (Default: OFF)

When receiving position data from an external or the built-in GPS receiver,* this function sends the data from the NMEA Output port to an external device.

*For only IC-M323G and IC-M324G.

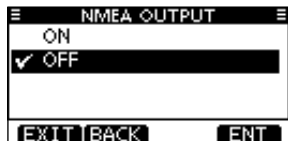

• DSC data output (Default: OFF)

When receiving a DSC call, this function makes the transceiver send the DSC data from its NMEA Output port to an external device.

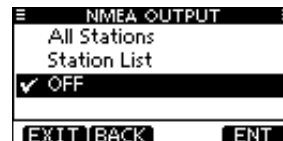

All Stations: Outputs the call from any vessel from the NMEA Output port.

Station List: Outputs the call from any vessels listed on the Individual ID screen.

OFF: Does not output any call to an external device.

◇ Remote ID (Default: 15)

Set a Remote ID number to between 1 and 69.

The Remote ID is included in the sentence of the Icom original NMEA format.



■ Connections

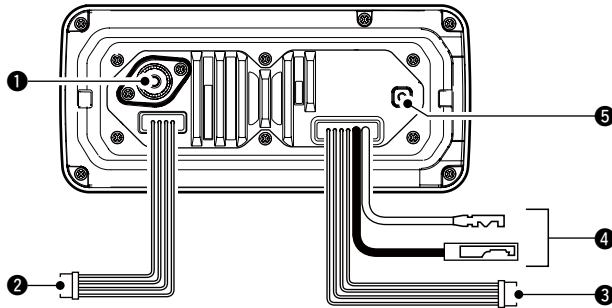

1 ANTENNA CONNECTOR

Connects to a marine VHF antenna cable's PL-259 connector.

CAUTION: Transmitting without an antenna may damage the transceiver.

2 NMEA IN/OUT LEADS

Brown: Talker B (Data-L), NMEA In (-)

White: Talker A (Data-H), NMEA In (+)

Connect to NMEA In lines of a PC or NMEA 0183 (ver. 2.0 or later) sentence format DSC, DSE compatible navigation equipment, to receive position data from other ships.

Green: Listener B (Data-L), NMEA Out (-)

Yellow: Listener A (Data-H), NMEA Out (+)

Connect to NMEA Out lines of a GPS receiver for position data.

- A NMEA 0183 ver. 2.0 or later RMC, GGA, GNS, GLL, VTG, GSV, and GSA sentence format compatible GPS receiver is required. Ask your dealer about suitable GPS receivers.

3 AF OUT LEADS

Blue: External Speaker (+)

Black: External Speaker (-)

Connects to an external speaker.

Orange: Data line

Gray: Data line

Used only for maintenance purpose.

NOTE for NMEA In/Out and AF Out leads:

- The connectors are attached to keep the leads together.
- Before connecting to a piece of equipment, you should cut the leads to remove the connector.

9 CONNECTIONS AND MAINTENANCE

■ Connections (Continued)

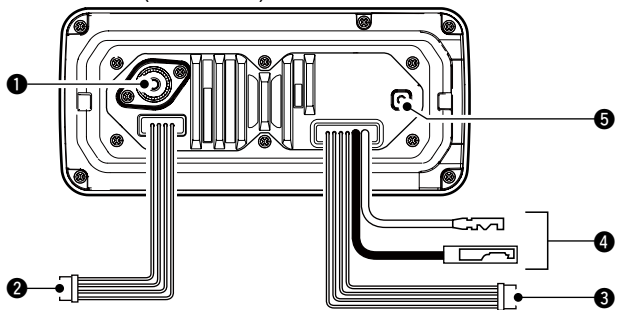

4 DC POWER CONNECTOR

Connects to a 13.8 V DC power source.

CAUTION: After connecting the DC power cable, NMEA leads or external speaker leads, cover the connector and leads with a vulcanizing tape, as shown below, to prevent water seeping into the connection.

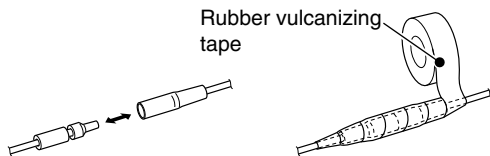

5 GROUND TERMINAL

Connects to a vessel ground to prevent electrical shocks and interference from other equipment occurring. Use a PH M3 × 6 screw (user supplied).

◇ Connect to the MA-500TR

Connect the transceiver to the high-density D-Sub 15-pin connector of the MA-500TR using the OPC-2014* cable. After connecting, an Individual DSC call can be made to the AIS target using the transponder without entering the target's MMSI code.

* The OPC-2014 is supplied with the MA-500TR

- **Listener A (Data-H) lead (Yellow):**
Connects to lead 3 of the OPC-2014.
- **Listener B (Data-L) lead (Green):**
Connects to lead 2 of the OPC-2014.
- **Talker A (Data-H) lead (White):**
Connects to lead 5 of the OPC-2014.
- **Talker B (Data-L) lead (Brown):**
Connects to lead 4 of the OPC-2014.

■ Antenna

A key element in the performance of any communication system is the antenna. Ask your dealer about antennas and the best place to mount them.

■ Fuse replacement

One fuse is installed in the supplied DC power cable. If the fuse blows or the transceiver stops functioning, track down the source of the problem, repair it, and replace the damaged fuse with a new one of the proper rating.

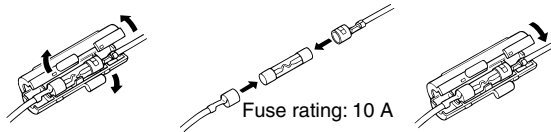

■ Cleaning

If the transceiver becomes dusty or dirty, wipe it clean with a soft, dry cloth.



DO NOT use harsh solvents such as benzine or alcohol, as they will damage transceiver surfaces.

■ Supplied accessories

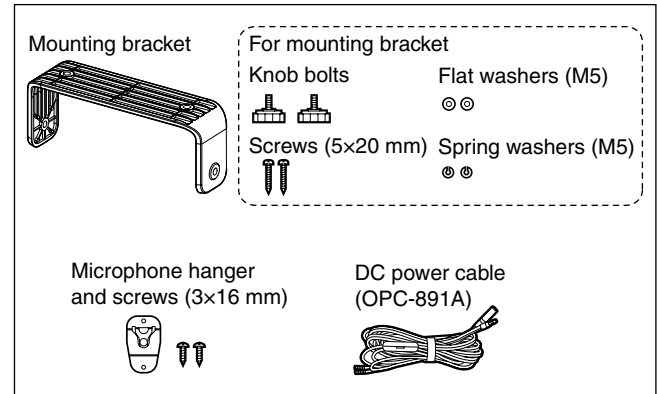

■ Mounting the transceiver

◆ Using the supplied mounting bracket

The universal mounting bracket supplied with your transceiver allows overhead or dashboard mounting.

- ① Mount the bracket securely to a surface which is more than 10 mm thick and can support more than 5 kg using the 2 supplied screws (5 × 20 mm).
- ② Attach the transceiver to the bracket so that the face of the transceiver is at 90° to your line of sight when operating it.

/// **KEEP** the transceiver and microphone at least 1 meter away from the vessel's magnetic navigation compass.

/// **NOTE:** Check the installation angle; the function display may not be easy-to-read at some angles.

/// **NOTE for the IC-M323G and IC-M324G:**

Built-in GPS receiver is located at the right top of the front panel.

If the transceiver is covered with any object that interrupts the GPS signals from the satellites, the GPS receiver will not calculate its position.

Therefore, when you use the built-in GPS receiver, be sure the transceiver is positioned so the GPS receiver has a clear view to receive signals from satellites.

• MOUNTING EXAMPLE

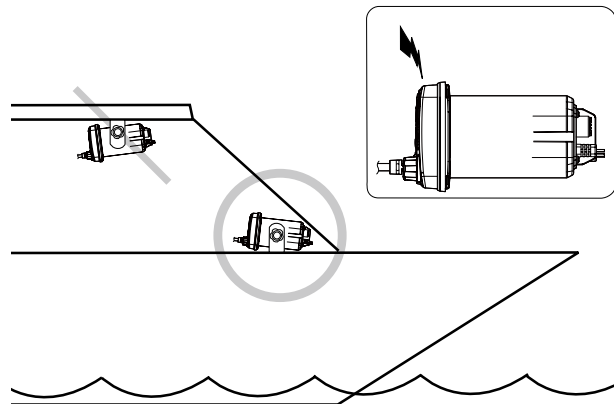
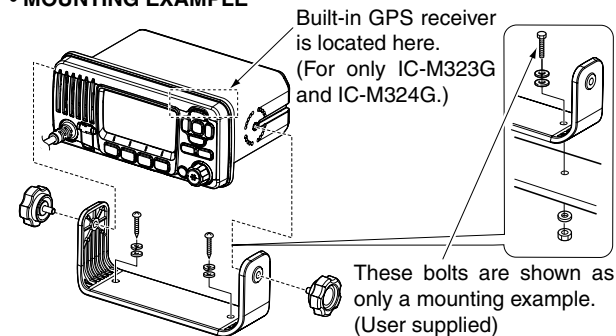

■ MB-132 installation

An optional MB-132 flush mount is available for mounting the transceiver to a flat surface, such as an instrument panel.

KEEP the transceiver and microphone at least 1 meter away from your vessel's magnetic navigation compass.

- ① Using the template on page 85, carefully cut a hole into the instrument panel, or wherever you plan to mount the transceiver.
- ② Slide the transceiver through the hole, as shown below.

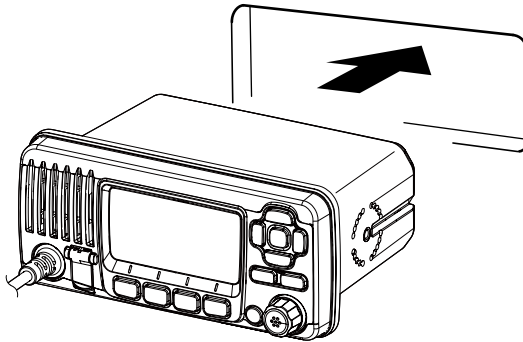

- ③ Attach the clamps on either side of the transceiver with 2 M5 × 8 mm supplied bolts.
 - Make sure that the clamps align parallel to the transceiver body.

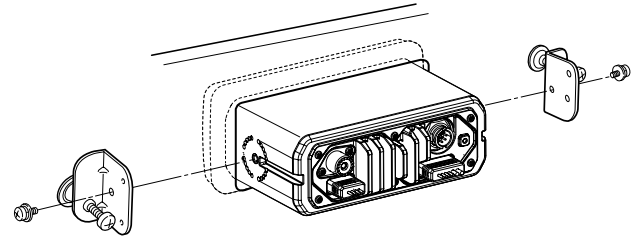

- ④ Tighten the end bolts on the clamps (clockwise) so that the clamps press firmly against the inside of the instrument control panel.
- ⑤ Tighten the locking nuts (counterclockwise) so that the transceiver is securely mounted in position, as shown below.
- ⑥ Connect the antenna and power cable, then return the instrument control panel to its original place.

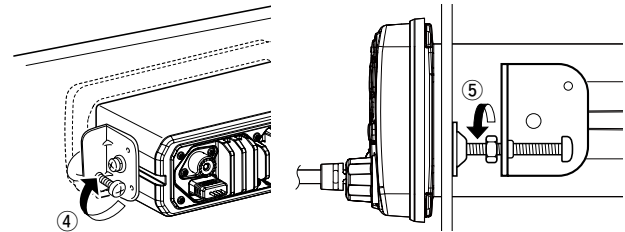

10 SPECIFICATIONS AND OPTIONS

■ Specifications

◇ General

- Frequency coverage:

| | |
|---------------------|---------------------|
| Tx IC-M323/IC-M323G | 156.000–161.450 MHz |
| IC-M324/IC-M324G | 156.025–157.425 MHz |
| Rx IC-M323/IC-M323G | 156.000–163.425 MHz |
| IC-M324/IC-M324G | 156.050–163.275 MHz |
- Mode:

| | |
|---------------|-------------|
| CH70 | 156.525 MHz |
| 16K0G3E (FM) | |
| 16K0G2B (DSC) | |
- Channel spacing: 25 kHz
- Operating temperature range: –20°C to +60°C; –4°F to +140°F
- Current drain (at 13.8 V):

| | |
|---------------|---------------|
| TX high | 5.5 A maximum |
| Maximum audio | 1.5 A maximum |
- Power requirement: (negative ground) 13.8 V DC nominal
- Frequency stability: ±1.5 kHz (–20°C to +60°C; –4°F to +140°F)
- Antenna impedance: 50 Ω nominal
- Dimensions (approximately): 180(W) × 82(H) × 135(D) mm; 7.1(W) × 3.2(H) × 5.3(D) inches (Projections not included)
- Weight (approximately): 1.2 kg; 2.6 lb

◇ Transmitter

- Output power: 25 W/1 W
- Modulation system: Variable reactance frequency modulation

- Maximum frequency deviation: ±5.0 kHz
- Spurious emissions:

| | |
|------------------|--------------------------|
| IC-M323/IC-M323G | Less than 0.25 μW |
| IC-M324/IC-M324G | Less than –70 dBc (high) |
| | Less than –56 dBc (low) |

◇ Receiver

- Receive system: Double conversion superheterodyne
- Sensitivity:

| | |
|----------------------|-------------------------------------|
| FM IC-M323/IC-M323G | –5 dBμ emf typical (at 20 dB SINAD) |
| IC-M324/IC-M324G | –13 dBμ typical (at 12 dB SINAD) |
| DSC IC-M323/IC-M323G | –4 dBμ emf typical (1% BER) |
| IC-M324/IC-M324G | –5 dBμ emf typical (1% BER) |
- Squelch sensitivity:

| | |
|------------------|----------------------|
| IC-M323/IC-M323G | Less than –2 dBμ emf |
| IC-M324/IC-M324G | Less than –10 dBμ |
- Intermodulation rejection ratio:

| | |
|---------------------|-------------------------------|
| FM IC-M323/IC-M323G | More than 68 dB |
| IC-M324/IC-M324G | More than 70 dB |
| DSC | More than 68 dBμ emf (1% BER) |
- Spurious response rejection ratio:

| | |
|-----|-------------------------------|
| FM | More than 70 dB |
| DSC | More than 73 dBμ emf (1% BER) |
- Adjacent channel selectivity:

| | |
|-----|-------------------------------|
| FM | More than 70 dB |
| DSC | More than 73 dBμ emf (1% BER) |
- Audio output power:

| | |
|------------------|---|
| IC-M323/IC-M323G | More than 2 W at 10% distortion into a 4 Ω load |
| IC-M324/IC-M324G | 4.5 W at 10% distortion into a 4 Ω load |

All stated specifications are subject to change without notice or obligation.

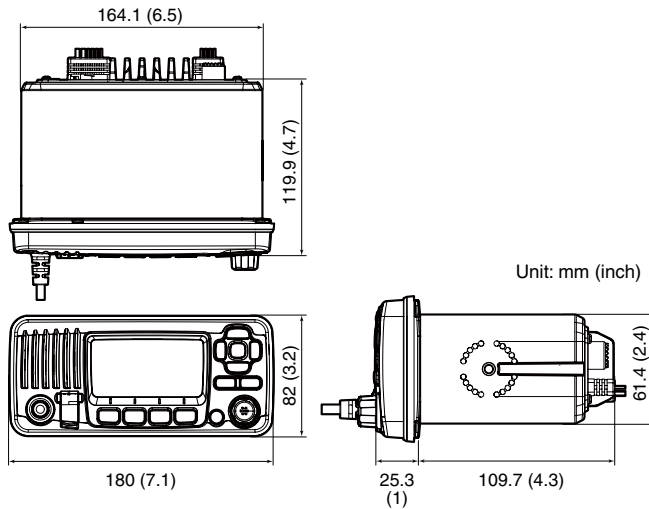

◇ Dimensions

■ Options

- **MB-132** FLUSH MOUNT KIT
To mount the transceiver to a panel.
- **MA-500TR** CLASS B AIS TRANSPONDER
To transmit individual DSC calls to a selected AIS targets.

Approved Icom optional equipment is designed for optimal performance when used with an Icom transceiver.

Icom is not responsible for the destruction or damage to an Icom transceiver in the event the Icom transceiver is used with equipment that is not manufactured or approved by Icom.

11 TROUBLESHOOTING

| PROBLEM | POSSIBLE CAUSE | SOLUTION | REF. |
|--|---|---|---------------------------|
| The transceiver does not turn ON. | <ul style="list-style-type: none">• Bad connection to the power source. | <ul style="list-style-type: none">• Check the connection to the transceiver and power source. | p. 76 |
| Little or no sound comes from the speaker. | <ul style="list-style-type: none">• Squelch level is set too high.• Volume level is set too low.• Speaker has been exposed to water. | <ul style="list-style-type: none">• Set the squelch to the threshold point.• Set the volume to a suitable level.• Remove the water with the AquaQuake function. | p. 11 p. 11 p. 15 |
| Transmitting is impossible, or high power cannot be selected. | <ul style="list-style-type: none">• Some channels are restricted to low power or receive only by regulations.• The output power is set to low. | <ul style="list-style-type: none">• Change channels.• Push [HI/LO] to select high power. | pp. 9, 10, 83 p. 12 |
| Scan does not start. | <ul style="list-style-type: none">• Favorite channels are not entered. | <ul style="list-style-type: none">• Set the desired channels as Favorite channels. | p. 17 |
| No beep sounds. | <ul style="list-style-type: none">• Beep tones are turned OFF. | <ul style="list-style-type: none">• Turn ON the beep tones in the CONFIGURATION menu. | p. 71 |
| Distress calls cannot be transmitted. | <ul style="list-style-type: none">• MMSI (DSC self ID) code is not entered. | <ul style="list-style-type: none">• Enter the MMSI (DSC self ID) code. | p. 7 |
| Built-in GPS receiver is not receiving valid position data. (For only IC-M323G and IC-M324G.) | <ul style="list-style-type: none">• The built-in GPS antenna is covered by an object that interrupts the GPS signals from the satellites. | <ul style="list-style-type: none">• Mount the transceiver in a place where no objects interrupts the satellites signal. | p. 78 |

13 INFORMATION

■ Country Code List

• ISO 3166-1

| | Country | Codes | | Country | Codes |
|----|----------------|-------|----|----------------|-------|
| 1 | Austria | AT | 18 | Liechtenstein | LI |
| 2 | Belgium | BE | 19 | Lithuania | LT |
| 3 | Bulgaria | BG | 20 | Luxembourg | LU |
| 4 | Croatia | HR | 21 | Malta | MT |
| 5 | Czech Republic | CZ | 22 | Netherlands | NL |
| 6 | Cyprus | CY | 23 | Norway | NO |
| 7 | Denmark | DK | 24 | Poland | PL |
| 8 | Estonia | EE | 25 | Portugal | PT |
| 9 | Finland | FI | 26 | Romania | RO |
| 10 | France | FR | 27 | Slovakia | SK |
| 11 | Germany | DE | 28 | Slovenia | SI |
| 12 | Greece | GR | 29 | Spain | ES |
| 13 | Hungary | HU | 30 | Sweden | SE |
| 14 | Iceland | IS | 31 | Switzerland | CH |
| 15 | Ireland | IE | 32 | Turkey | TR |
| 16 | Italy | IT | 33 | United Kingdom | GB |
| 17 | Latvia | LV | | | |

TEMPLATE 14

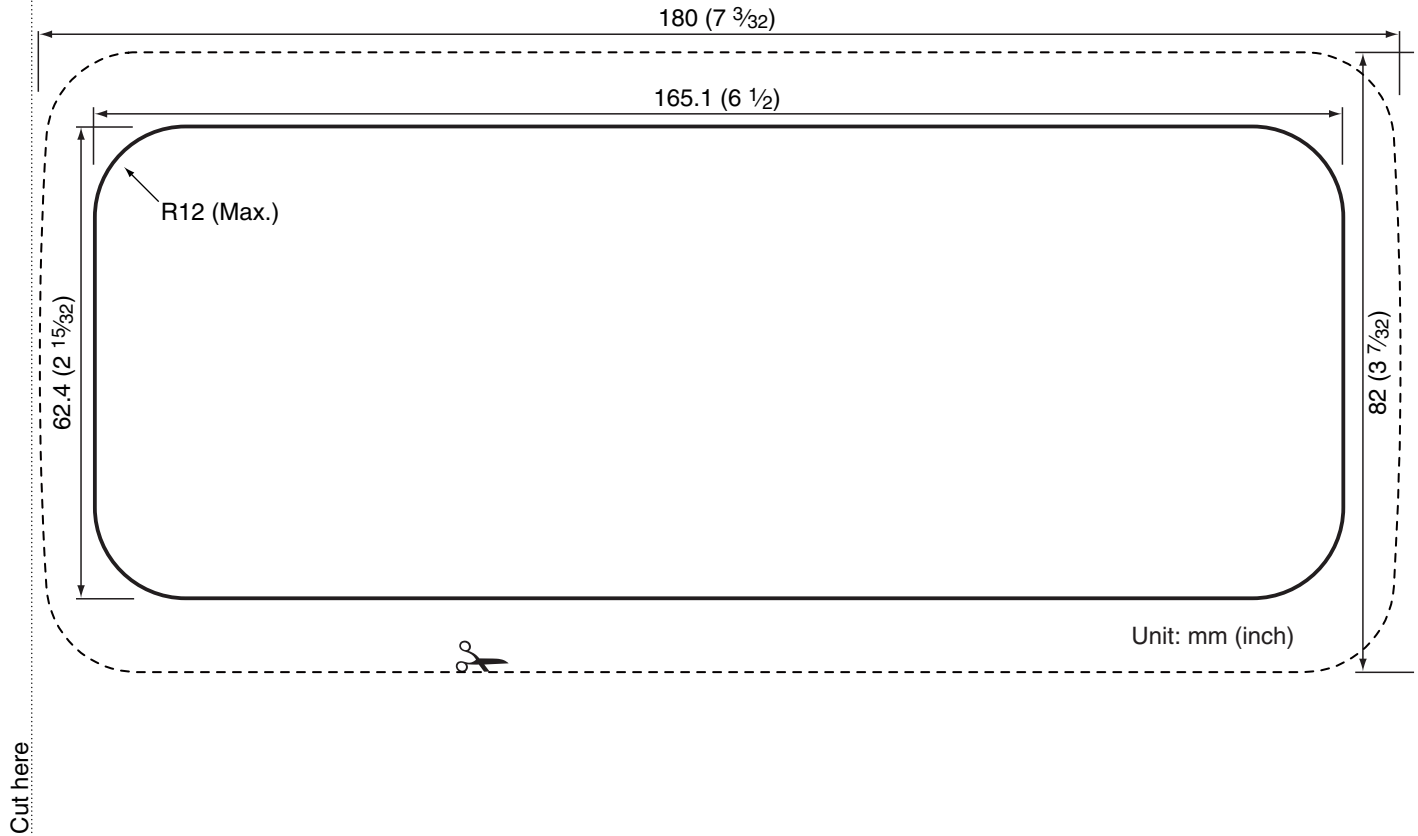

13
14

A

Accessories, supplied.....77

Acknowledgement, Automatic62

Alarm64

All Ships call

 Making a call.....34

 Receiving a call55

Antenna77

AquaQuake.....15

ATIS code8

B

Backlight level.....15

C

Call channel

 Selecting a Call channel.....9

 Entering a Call channel data.....14

Call log

 Received Call log60

 Transmitted Call log.....59

Channel 169

Channel 16 Switch function.....63

Channel 70 Squelch level64

Channel group.....10

Channel List.....83

Channel Name.....13

Cleaning77

Connections.....75

Country Code List.....84

D

Display contrast71

Distress Acknowledgement52

Distress call

 Making a call.....23

 Canceling a call26

 Receiving a call52

Distress Relay Acknowledgement53

Distress Relay Call53

DSC Loop Test.....65

DSC Settings.....62

DUALWATCH/TRI-WATCH18

E

Explicit Definitionsi

F

Favorite channels17

Front panel.....2

Function display.....4

Fuse replacement.....77

INDEX

| G | | M | |
|--------------------------------|----|--------------------------------|----|
| Geographical Area Call | 55 | MB-132 installation | 79 |
| Group call | | Menu Screen | |
| Making a call..... | 32 | Menu screen items..... | 69 |
| Receiving a call | 55 | Using the Menu screen..... | 68 |
| Group ID | | Microphone..... | 6 |
| Entering ID | 20 | Microphone Lock function..... | 14 |
| Deleting ID..... | 21 | MMSI code | 7 |
| | | Mounting the transceiver | 78 |
| I | | N | |
| IMPORTANT | i | NMEA Output | 74 |
| Inactivity Timer..... | 73 | | |
| Individual Call | | O | |
| Making a call | 27 | Operating Rules..... | 1 |
| Making an acknowledgement..... | 30 | Operation, basic | 9 |
| Receiving a call | 54 | Options | 81 |
| Individual ID | | P | |
| Entering ID | 19 | Polling Request Call | |
| Deleting ID..... | 21 | Making a call | 39 |
| Installation | | Making a reply call | 50 |
| Template | 85 | Receiving a call | 58 |
| K | | Position and time | 22 |
| Key Assignment..... | 72 | Position Report Call | |
| Key Beep | 71 | Making a call | 37 |
| | | Making a reply call | 48 |
| | | Receiving a call | 57 |

Position Request Call
 Making a call35
 Making a reply call45
 Receiving a call56
 PRECAUTIONS (English)..... vi
 PRÉCAUTIONS (Français)..... vii

R

Receiving.....12
 Remote ID74

S

Scan
 Scan resume timer70
 Scan types.....16
 Starting a scan17
 Softkey function6
 Specifications80
 Squelch.....11

T

Test Acknowledgement Call
 Making a call43
 Receiving a call.....59
 Test call
 Making a call41
 Making an acknowledgement43
 Receiving a call.....58
 Transmitting12
 Troubleshooting82

U

UTC Offset.....73

V

Volume.....11

W

Weather alert.....71
 Weather channel11

Count on us!

< Intended Country of Use >

AT BE CY CZ DK EE
FI FR DE GR HU IE
IT LV LT LU MT NL
PL PT SK SI ES SE
GB IS LI NO CH BG
RO TR HR

A-7182D-1EX-①
Printed in Japan
© 2014 Icom Inc.

Printed on recycled paper with soy ink.

Icom Inc.

1-1-32 Kamiminami, Hirano-ku, Osaka 547-0003, Japan